

snom



Short User Manual
IP Phone D862

TABLE OF CONTENTS

Copyright, Trademarks, GPL, Legal Disclaimers	4
Important information	5
Safety instructions	5
Standards conformance.....	6
Product specifications.....	7
Disposal of the deviceCleaning.....	7
Setting up the phone	8
Delivery Content.....	8
Attaching footstand and handset.....	8
Connecting the phone	10
Initializing and registering the phone.....	11
Initialization.....	11
Correcting the clock	12
Getting to know your phone.....	14
At a glance.....	14
LED indicators.....	16
Hard keys.....	17
User mode/administrator mode	17
User names and passwords.....	17
Setting HTTP user name and password.....	18
Setting user/admin mode on the phone	18
Settings	19
The phone's web interface	19
How the web interface works	19
Directory.....	20
Ringtones.....	20
Using the phone	21
Making calls	21
Selecting identity for current outgoing call.....	21
Using different audio devices	21
Handset.....	21
Headset.....	21
Speakerphone.....	21
Accepting calls	22
Using different audio devices.....	22
Automatically accepting calls	22
Active calls.....	22

Hold.....	22
Conference	23
Transferring calls	24
Attended transfer	24
Blind transfer.....	24
Terminating calls.....	26
Call lists.....	26
Software update	27
Manual update.....	27
Auto provisioning.....	27
SRAPS.....	27
Troubleshooting	28
Contacting Snom Support.....	28
Traces	28
Appendix 1 - GNU General Public License	30

Copyright, Trademarks, GPL, Legal Disclaimers

© 2023 Snom Technology GmbH

All Rights Reserved.

Snom, the names of Snom products, and Snom logos are trademarks owned by Snom Technology GmbH. All other product names and names of enterprises are the property of their respective owners.

Product specifications are subject to change without notice.

Snom Technology GmbH reserves the right to revise and change this document at any time, without being obliged to announce such revisions or changes beforehand or after the fact.

Texts, images, and illustrations and their arrangement in this document are subject to the protection of copyrights and other legal rights worldwide. Their use, reproduction, and transmittal to third parties without express written permission may result in legal proceedings in the criminal courts as well as civil courts.

When this document is made available on Snom's web page, Snom Technology GmbH gives its permission to download and print copies of its content for the intended purpose of using it as a manual. No parts of this document may be altered, modified or used for commercial purposes without the express written consent of Snom Technology GmbH.

Although due care has been taken in the compilation and presentation of the information in this document, the data upon which it is based may have changed in the meantime. Snom therefore disclaims all warranties and liability for the accurateness, completeness, and currentness of the information published, except in the case of intention or gross negligence on the part of Snom or where liability arises due to binding legal provisions.

Our firmware includes some source code that may be used and modified by anyone and everyone under the GNU Public License (GPL) (see "Appendix 1 - GNU General Public License" on page 30), provided they, in turn, make it available to everyone else with the same licensing agreement. Please go to <https://www.snom.com/en/footer/discover-snom/gtc/source-code-gpl-open-source/> for the original GPL license and the source code of components licensed under GPL and used in Snom products.

Important information

Please read the instructions on safety and disposal and on how to set up and use the device before using it and also give them to other users to read or inform those users of their contents. Save this manual and do not give the device to third parties without it.

Attention: This "Short User Manual" has been derived from the more extensive English and German only "User Manual" to give non-English or non-German speaking user groups a more concise overview in their own language. For more detailed explanations, we therefore recommend consulting the "User manual".

Safety instructions

Follow the instructions in this manual and other applicable documentation of the device.

- This device is designed for professional use.
- **Warning:** Changes or modifications to this unit not expressly approved by the party responsible for compliance could void the user's authority to operate the equipment.
- **Warning:** The product included (ITE) in this manual is to be connected only to PoE networks without routing to the outside plant.
- The socket outlet for the power adaptor must be near the equipment and easily accessible.
- Mount the device only at heights not exceeding 2m.
- Follow the instructions in this manual and other applicable documentation of the device.
- If the phone is not supplied with power via the Ethernet cable, use only a power adapter expressly recommended by Snom Technology. Other power supplies may damage or destroy the phone, affect its behavior, or induce noise.
- Avoid placing the cables where people may trip over them or where they may be exposed to mechanical pressure as this may damage them.
- This device is for indoor use only! NOT FOR OUTDOOR USE!
- Do not install the device in rooms with high humidity (for example, in bathrooms, laundry rooms, damp basements). Do not immerse the device in water and do not spill or pour liquids of any kind onto or into the device.
- Do not install the device in surroundings at risk for explosions (paint shops, for example). Do not use the device if you smell gas or other potentially explosive fumes.
- Do not use the device during thunderstorms. Lightning striking the power grid may cause electric shocks.
- **Warning:** The handset contains a magnet, and its earpiece may attract small dangerous objects such as needles or pins. Please ensure before each use that no such objects are present.
- Safety status of input/output connections comply with SELV (Safety Extra Low Voltage) requirements.
- **Warning:** To avoid electric shock, do not connect safety extra-low voltage (SELV) circuits to telephone-network voltage (TNV) circuits. LAN ports contain SELV circuits, and PSTN ports contain TNV circuits. Some LAN and PSTN ports both use RJ-45 (8P8C) connectors. Use caution when connecting cables.
- SELV (Safety Extra Low Voltage) compliance. Safety status of input/output connections comply

with SELV requirements.

Warning: To avoid electric shock, do not connect safety extra-low voltage (SELV) circuits to telephone-network voltage (TNV) circuits. LAN ports contain SELV circuits, and PSTN ports contain TNV circuits. Some LAN and PSTN ports both use RJ-45 (8P8C) connectors. Use caution when connecting cables.

Standards conformance



This device complies with the essential health, safety, and environmental requirements of all relevant European directives and UK legislation. The declaration of conformity can be downloaded at <https://www.snom.com/conformity>.

This product meets the applicable Innovation, Science and Economic Development Canada technical specifications.

This phone is FCC Class A verified and meets US health, safety, and environmental standards.

Unauthorized opening, changing, or modifying the device will cause the warranty to lapse and may also result in the loss of CE, UKCA, and ISED conformity and the FCC verification. In case of malfunction contact authorized service personnel, your seller, or Snom.

Additional information U.S.A.

Note: This equipment has been tested and found to comply with the limits for a Class A digital device, pursuant to part 15 of the FCC Rules. These limits are designed to provide reasonable protection against harmful interference when the equipment is operated in a commercial environment. This equipment generates, uses, and can radiate radio frequency energy and, if not installed and used in accordance with the instruction manual, may cause harmful interference to radio communications. Operation of this equipment in a residential area is likely to cause harmful interference in which case the user will be required to correct the interference at his own expense.

Consumer Information

- a. This equipment complies with Part 68 of the FCC rules and the requirements adopted by the ACTA. On the bottom of this equipment is a label that contains, among other information, a product identifier in the format US:AAAEQ##TXXXX. If requested, this number must be provided to the telephone company.
- b. An applicable certification jacks Universal Service Order Codes (USOC) for the equipment is provided (i.e., RJ45C) in the packaging with each piece of approved terminal equipment.
- c. A plug and jack used to connect this equipment to the premises wiring and telephone network must comply with the applicable FCC Part 68 rules and requirements adopted by the ACTA. A compliant LAN cable (RJ45) and modular plug is provided with this product. An RJ45 jack should normally be used for connecting to the SIP equipment through the LAN cable. See installation instructions for details.
- d. If this equipment causes harm to the telephone network, the telephone company will notify you in advance that temporary discontinuance of service may be required. But if advance notice isn't practical, the telephone company will notify the customer as soon as possible. Also, you will be advised of your right to file a complaint with the FCC if you believe it is necessary.
- e. The telephone company may make changes in its facilities, equipment, operations or procedures that could affect the operation of the equipment. If this happens the telephone

company will provide advance notice in order for you to make necessary modifications to maintain uninterrupted service.

- f. Should you experience trouble with this equipment, please contact: Snom Technology GmbH, 1 (339) 227-6160 (select option 2) for repair or warranty information. If the equipment is causing harm to the telephone network, the telephone company may request that you disconnect the equipment until the problem is resolved.
- g. Please follow instructions for repairing if any (e.g. battery replacement section); otherwise do not alternate or repair any parts of device except specified.
- h. Connection to party line service is subject to state tariffs. Contact the state public utility commission, public service commission or corporation commission for information.
- i. **NOTICE:** If your home has specially wired alarm equipment connected to the telephone line, ensure the installation of this device does not disable your alarm equipment. If you have questions about what will disable alarm equipment, consult your telephone company or a qualified installer.
- j. This equipment is hearing aid compatible.

NOTICE: According to telephone company reports, AC electrical surges, typically resulting from lightning strikes, are very destructive to telephone equipment connected to AC power sources. To minimize damage from these types of surges, a surge arrester is recommended.

Product specifications

- **Safety:** IEC 62368-1
- **Connectors:**
 - 2 x RJ45 (Ethernet): 1 x LAN, 1 x PC
 - 2 x 4P4C (handset, optional headset)
 - 1 x RJ12 (for EHS)
 - 1 x USB 2.0 port, type A
 - 1 x coaxial power connector
- **Ethernet:** 2 x IEEE 802.3 / 1 Gigabit Ethernet switch
- **Power:** Power over Ethernet (PoE), IEEE 802.3af, Class 3. If PoE is not available, one of the following power adapters (not included in delivery) can be ordered separately:
 - Mass Power, model NBS12E050200UV, Snom PN 00004570 (EU, U.S.)
 - Rongweixin, model R122-0502000ID, Snom PN 00004571 (U.S.)

Disposal of the device



This device is subject to European Directive 2012/19/EU and may not be disposed of with general household garbage. If you do not know where you may dispose of the device at the end of its lifespan, contact your municipality, your local waste management provider, or your seller.

Cleaning

To clean the device, use an anti-static cloth. Please avoid cleaning liquids as they might damage the surface or internal electronics of the device.

Setting up the phone

Delivery Content

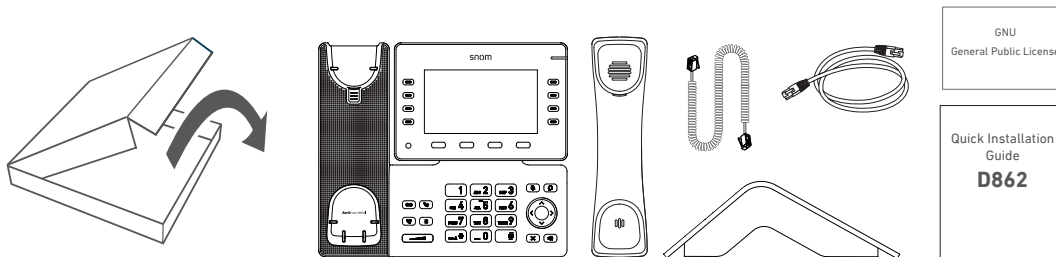

- Base phone unit
- Footstand
- Handset
- Handset cord
- Ethernet cable
- Quick Installation Guide, GNU General Public Licence

Attaching footstand and handset

Note: Before attaching the footstand to the phone, plug the long end of the handset cord into the connector labelled "☞" on the back of the phone and place the cord in the cable guide.

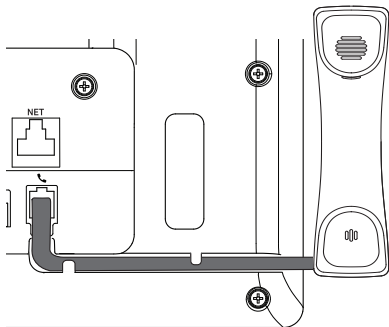

1. Place the top of the grooves on the footstand below the slideguides on the back of the phone.
2. Push the footstand upwards onto the slideguides until it locks into place.

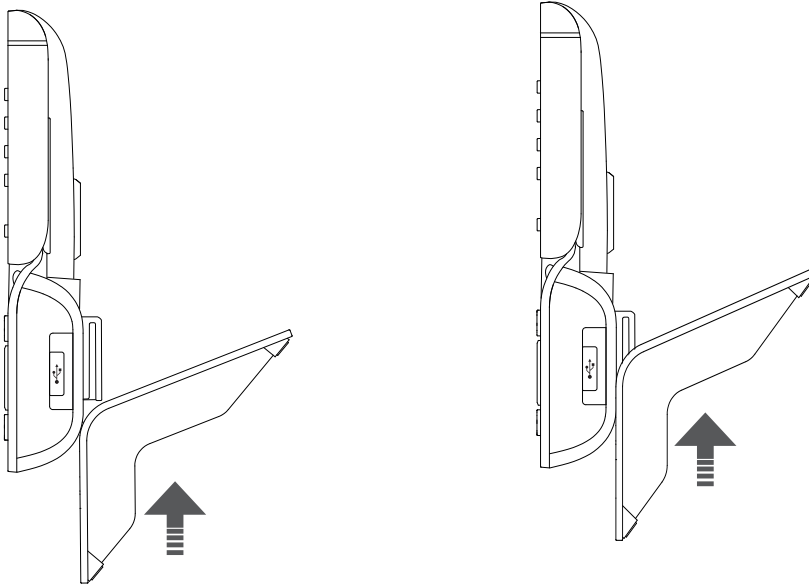

3. Plug the short end of the handset cord into the connector on the handset.
4. Place the phone on an even, horizontal surface.

Connecting the phone

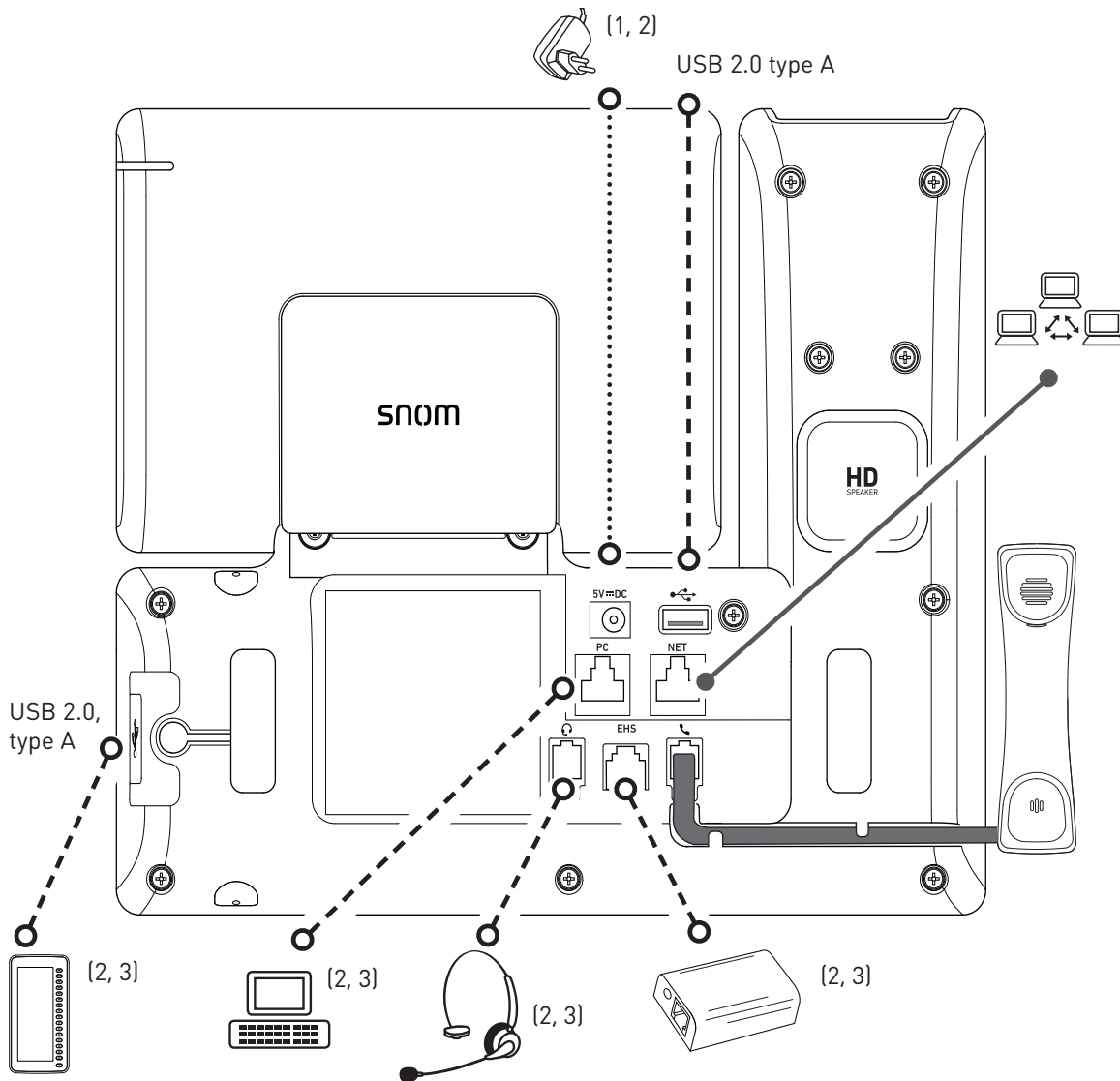

- (1) If PoE not available ●.....●
- (2) Not included in delivery
- (3) Optional ●-----●

The phone can be operated with Power over Ethernet (PoE) provided via the network cable or, if PoE is not available in your network, with the separately available 5V DC power adapter (see "Product specifications" on page 7).

- Plug one end of the Ethernet (network) cable into the RJ45 connector labeled **"NET"** and the other one into the network side to establish a data link.
- If PoE is not available, insert the plug of the power supply into the connector labeled **"5V DC"** and hook up the plug to the wall outlet.
- The second RJ45 connector, labeled **"PC"**, is for daisy-chaining further Ethernet devices without the need for a second Ethernet connection line.

Initializing and registering the phone

Initialization

Snom phones are plug-and-play. Once the phone is connected to your network, it will begin to initialize.

Note: Normally the initialization is completely automatic, using DHCP. If the phone cannot discover a DHCP server in the subnet, you will be asked: Are you using DHCP? If your network does not support DHCP, press **X** and enter the IP address, netmask, IP gateway, and DNS server manually. Ask your Internet service provider or your network administrator for them.

If your network does not support DHCP, follow the instructions given.

When the phone has been connected, it will show the welcome screen with the IP address of the Phone Manager. Enter the IP address into the address bar of your computer's browser and press ENTER to open the Phone Manager.

Welcome to Phone manager!

Please log in with your user credentials.

Username
Your account username

Password
Your secret password

Authenticate

1. Click **Authenticate**. The **Home** page opens.

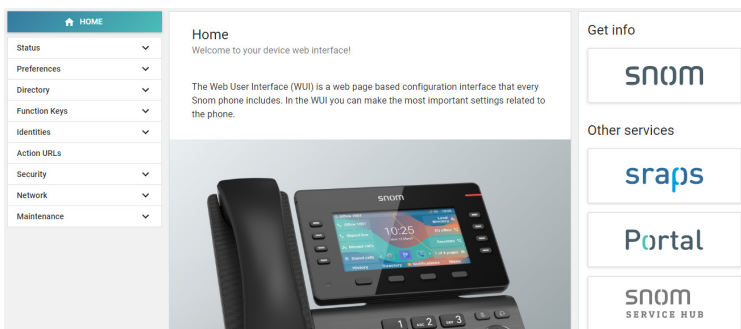

2. Click **Preferences** in the vertical menu on the left side.
3. Select the **language** and click **Apply**,
4. Select the **timezone** and click **Apply**.
5. Select the **tone scheme** (dial tone) and click **Apply**.
6. Click **Identities** in the vertical menu on the left side and select **Profile**.
7. Enter the **account number**, the **registrar**, and the **password** received from your Internet service provider or administrator and click **Apply**.

After successful registration you will see the idle screen with the registered identity in the upper left corner:

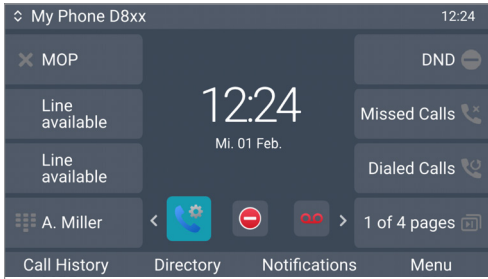

Note: If the account is preceded by a red dot  **My Phone D8** and the phone is not working, the server may be down, either for servicing or due to a malfunction. Press the key underneath **Notifications** to see details.

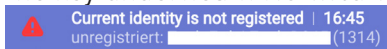

The registration and initialization should be completed as soon as the server is up and running again. You may want to check with your administrator or your provider if nothing happens within a reasonable amount of time.

Correcting the clock

The phone receives the time and date from your NTP time server. If the time and/or date on the display are incorrect, you may need to set the correct time zone in the phone manager.

1. Click **Preferences**, then **Time & Date**.
2. In **Time**, select the timezone from the drop-down menu of **Time Zone** and click **Apply**.

If the time is still incorrect, there may be a problem with the time server. Contact your network administrator or your IP provider.

Time and date formats

The default settings are 24-hour clock, e.g. 17:35, and U.S. date format MM/DD/YEAR, eg. 11/23/2022. You can change both in the phone manager.

1. Click **Preferences**, then **Appearance**.

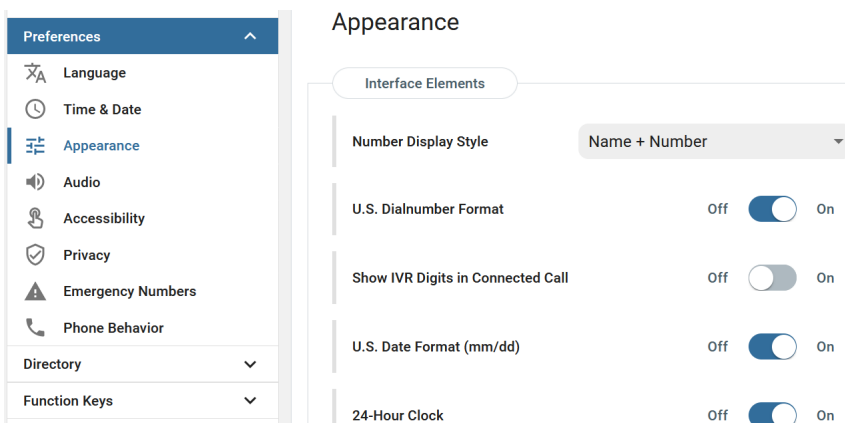

2. Click the slider of **U.S. Date Format** from **On** to **Off** if you want to change the date to the European format DD.MM.YEAR, e.g. 23.11.2022.

3. Click the slider of **24-Hour Clock** from **On** to **Off** if you want to change the time format to the 12-hour AM and PM format.

Getting to know your phone

At a glance

The factory settings at a glance:

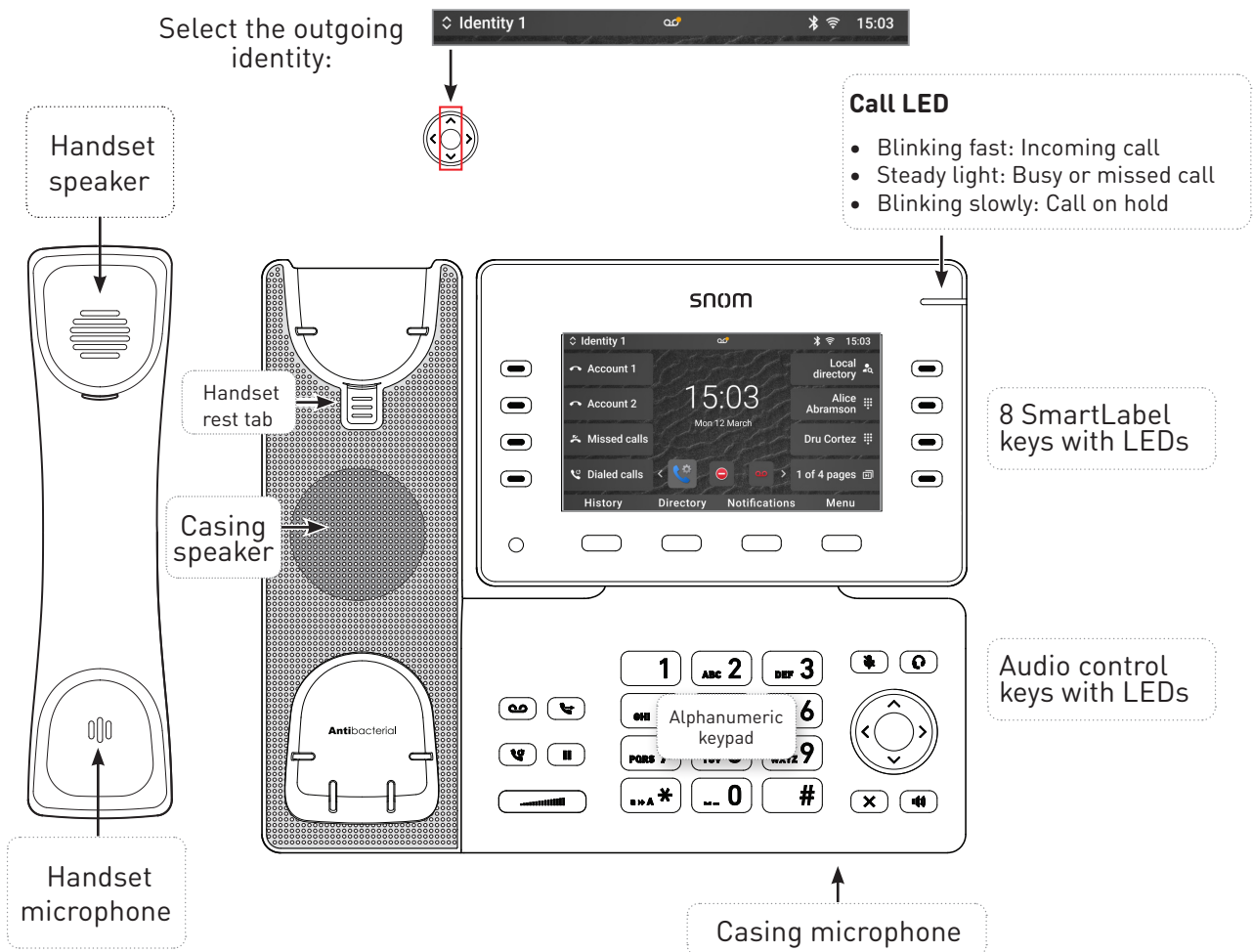

Context-sensitive, programmable function symbols and function keys F1–F4

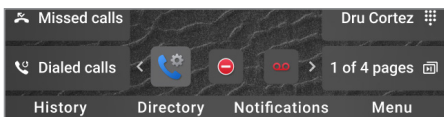

Press the function key underneath the display symbol to activate the function, open the list etc. depicted by the symbol above the key.

Standard functions available on idle screen. Default settings depend on the firmware installed on the phone.

- | | |
|--|--|
| <input type="button" value="Directory"/> | Internal phone directory |
| <input type="button" value="History"/> | Call lists (missed, received, dialled calls) |
| <input type="button" value="CFwd"/> | Forwarding all calls (turning CFwd on/off) |
| <input type="button" value="Menu"/> | Settings menu |
| <input type="button" value="Notifications"/> | Status information (call forwarding active, passwords not set, missed calls, etc.) |

Audio control keys

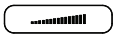

Adjusting the volume of the ringer when the phone is idle or ringing or of the handset/casing loudspeaker when in a call



Mute/unmute microphone



Toggling between handsfree and handset mode. Press to dial number and accept calls on speakerphone.



Headset mode on/off

Navigation keys

Canceling actions & input, and returning to previous screen

Terminating calls on speakerphone and in headset & handset modes



From idle screen: Select outgoing identity

In other contexts (settings, lists): Navigate up/down

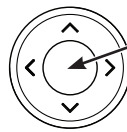

On idle screen: Select a favicon

In other contexts: Navigate/space left

Confirming, saving actions & input, and returning to previous screen

Accepting calls on speakerphone and in headset mode

From idle screen: call features menu

Favicons: shortcuts to menus

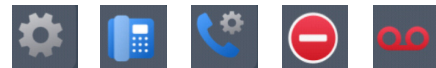

Preferences System Call Features DND Mailbox

Dedicated, customizable function keys



MWI key with LED
LED is lit when message is waiting on mailbox (if mailbox supplied on PBX)
Press key to listen to message(s)



Redial



Transfer



Hold

SmartLabel keys P1–P32, freely programmable, self-labeling, with LEDs



Default setting: Line

Fast-blinking LED: Incoming call. Press blinking key or to accept

Steadily lit LED: In call

Slow-blinking LED: Call on hold

- P1– P8
- P9 – P16
- P17 – P24
- P25 – P32

Default page keys: P8, P16, P24, P32

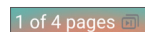

Star key

In editing mode: Press for one second to change input mode (numerals > lower case > upper case) or press briefly to type *

On idle screen: Press for 3 seconds to **lock/unlock the keypad**

LED indicators

Call indicator

The bright-red LED situated on the top right corner of the phone indicates incoming, ongoing, held, and missed calls. LED status indications:

- Blinking rapidly when a call is coming in.
- Glowing steadily when dialing, when in a call, and when you have missed a call. To turn the LED off after a missed call, press the right arrow  on the navigation key to view the **Missed calls** menu and simultaneously turn off the LED.
- Blinking slowly when you have put a call on hold.

Function key LEDs

SmartLabel keys P1–P32

Depending on the function mapped onto the key, the red or green LEDs on the key will be activated when the key event occurs. The factory setting is red LED and "line". The LEDs of a line key will:



- blink rapidly when a call is ringing on the line;
- glow steadily when there is an ongoing call on the line;
- blink slowly when a call is on hold on the line;
- be off when the line is free.

When other functions are mapped onto the keys, the LEDs may glow or blink. For example: When the "extension" function has been mapped onto a key and monitoring of extensions is enabled on both phones, the LED will

- blink rapidly when a call is ringing on the extension;
- glow steadily when the extension is busy;
- be off when the extension is not busy

MWI key : Has a red LED that lights up when there is a new message on the mailbox.

Mute key : Has a red LED that lights up when and as long as the microphone is muted.

Speakerphone  **and headset**  **keys**: Have green LEDs that light up when and as long as speakerphone or headset mode, respectively, are turned on.

Hard keys

Hard keys are an integral part of the D865 phone user interface (PUI) and allow user input and interaction. Please refer to chapter "At a glance" on page 14 to identify hard keys on the phone and learn about their factory values. These 43 hard keys have the following functionality:

- **4 context-sensitive, programmable function keys (F1 - F4)** are located directly below the display and can be programmed on the **Function Keys** page of the phone's web interface (WUI) with a number of key events; these functions will then be available when the phone is in idle mode.
- **1 alphanumeric keypad** consisting of **12 hard keys**, located in the center of the lower device part, further details see page 15.
- **5-way navigation key (up, down, left, right, confirmation) and 1 cancel key** are found on the right side next to the alphanumeric keypad and can be programmed with the key events available in their drop-down menus, further details see page 15.
- **4 preprogrammed, variably programmable function keys** have their factory settings printed on the key, see page 15. Other functionalities can also be programmed onto them.
- **5 audio control keys** are used to adjust the volume (2), for muting and unmuting the microphone (1), to activate speakerphone (1) and headset mode (1), further details see page 15.
- **8 SmartLabel keys (freely programmable function keys with LEDs P1 - P32)** on the both sides of the display control the SmartLabels, further details see page 15.

User mode/administrator mode

Snom phones can be operated in administrator or user mode. In administrator mode, all settings are accessible and can be modified; in user mode, a number of settings are not accessible. The factory default is user mode.

For the D8xx series phones, user and administrator mode on the phone and on the web interface are set independently of each other. If the phone is running in user mode, you will still be able to open the phone manager in admin mode if you have the admin name and password.

When the phone is running in user mode, the administrator password is required to switch to administrator mode. If your phone is administered centrally, user mode may be the rule. Please check with your network administrator or IP provider.

When the web interface is opened for the first time upon initialization or after a reboot, you will see the Phone Manager. See "Initialization" on page 11 for further information.

User names and passwords

We urge you to set an administrator PIN and an HTTP password to protect your phone. There are no default passwords. **Please note:**

- Administrator PIN. If you do not set an administrator password, an unauthorized third party with access to the phone could set an administrator password unknown to you. In such a case, you would no longer be able to switch from user mode to administrator mode to regain access to all phone settings.
- HTTP user name and HTTP password. If you do not set these, you make it easier for experienced hackers to break into your system.

Note: Be sure to write down your admin password and your HTTP user name and password and store them in a secure place.

Without the administrator PIN, you will not be able to return the phone and the web interface from user mode to administrator mode; many settings will be inaccessible. Without HTTP user name and password you cannot open the phone's web interface.

You can set and change the data in the phone manager at any time.

1. Press the function key underneath **Menu** on the phone's display and select **Help** to look up the phone's IP address.
2. Enter the IP address into the browser's address bar on a computer in the same network as the phone.
3. If user or admin name and password have been set, enter them and click **Authenticate**; if not, just click **Authenticate**.

Setting HTTP user name and password

1. Click **Network** in the left lateral menu.
2. Click **Advanced**.
3. Scroll down to **HTTP Server** and set the **User** name and **Password** in the respective text fields.
 - User name. Valid values are character strings of letters and numerals, e.g. john or jh24.
 - Password. Text string.
4. Select the **authentication scheme** to be used by clicking **on** or **off** on the toggle switch.
 - Basic scheme: off.
 - Digest Authentication Scheme: on. This is the more secure option and the default setting.

Setting user/admin mode on the phone

1. In the **Main menu**, select System.
2. If the phone is running user mode (i.e., administrator access is **off**), press **</>** to change the setting to **on**. You will be prompted to enter the administrator access PIN. Enter the PIN and press **Confirm**.
3. If the phone is running admin mode (i.e., administrator access is **on**), press **</>** to change the setting to **off**.
4. Press **Back** to return to the main menu.

Settings

Phone menu

Settings can be adjusted on the phone and in the Phone Manager, the phone's web interface.

1. On the idle screen, press **MENU** to open the main menu on the display (Fig. 1).

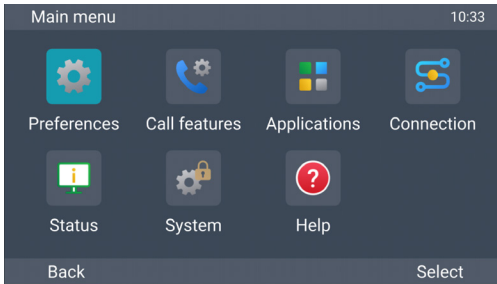

Fig. 1

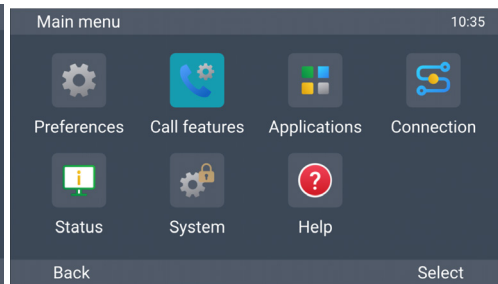



Fig. 2

2. Select a menu with the navigation keys $\wedge \vee \langle \rangle$ (Fig. 2).
3. Press **Select** or  to open the highlighted menu.

The phone's web interface

How the web interface works

Available items in the vertical menu on the left side of the window depend on whether the phone is running in user or administrator mode.

1. Click a menu item to show the submenus.
2. Click a submenu to open its content in the body.

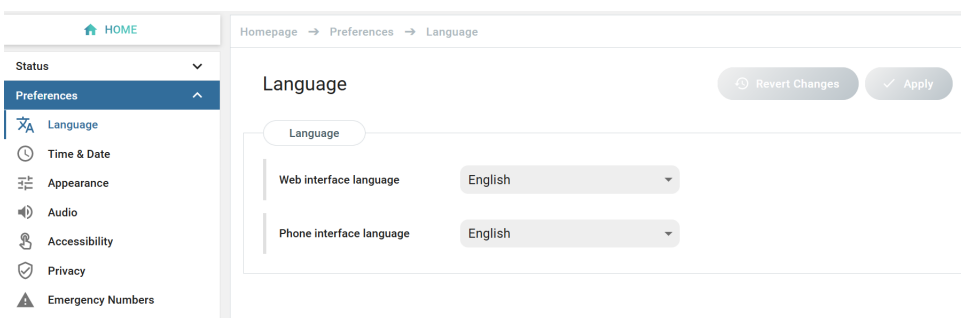

3. If you change a setting, the **Apply** and **Revert Changes** buttons become available. Click **Apply** to save your change(s) before opening another submenu.

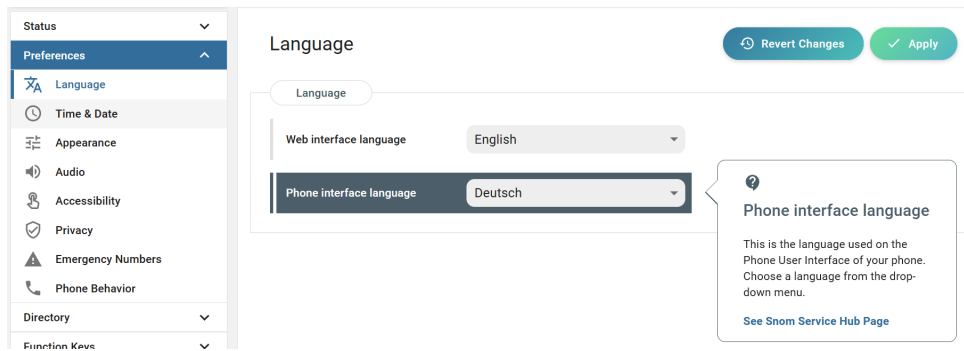

Note: Changes will be lost if you open another page or if you close the web interface without first clicking **Apply**.

When you click a setting, a pop-up window with a question mark at the top appears. It contains information on the setting and a link to Snom's Service Hub where you may find more information about it,

Web settings overriding manual phone settings

In some cases settings activated on the web interface override manual settings on the phone. If a setting you have made on the phone does not appear to take effect, look for a conflicting setting on the web interface or check with your administrator.

Directory

The directory is the built-in directory of the phone. It can hold up to 10,000 entries. Entries can be added and edited on the phone's web interface.

Any changes you make on the web interface will not take effect until you click on "Save" or on "Apply" and "Save", depending on your firmware version. Changes will be lost if you open another page of the web interface without first clicking on "Apply"/"Save".

Ringtones

The phone has 10 built-in ringtones that can be assigned to identities, group types, and contact types. It is also possible to download a custom melody.

Using the phone

This section describes the functions of the phone with the factory default settings. If your phone was installed and/or set up by someone else, the default settings may have been changed. Please check with that person or company if the phone does not react as described here.

The caller information displayed on the screen is controlled by a setting on the phone's web interface. The default setting is "Name + Number". To change the setting, click **Preferences** in the left lateral menu, then **Appearance**. In the **Interface elements** section, select an option from the pull-down menu **Number Display Style**. The other options are Full contact, name, number, and number + name.

Making calls

Selecting identity for current outgoing call



Your current outgoing identity is shown on the left side of the status line. To select another configured identity, press \wedge / \vee on the navigation key.

Using different audio devices

Handset

- Pick up the handset, enter the phone number, and press  OR
- enter the phone number and pick up the handset.

Headset

- Enter the phone number and press .

Speakerphone

- Enter the phone number and press **Dial** or .

Accepting calls

Using different audio devices

Handset: Pick up the handset.

Headset: Press .

Speakerphone: Press **Answer** or  or .

Automatically accepting calls

The default is **off**. Turning the function on for an identity (admin mode only): on the phone's web interface click **Identities**, select the identity, and click **SIP**. Scroll down to **Auto answer** and click **on** on the on/off toggle switch. With this setting, your phone will automatically accept incoming calls when it is idle.

Calls will be accepted on speakerphone, and you will be alerted acoustically by a single long beep. Press the headset key  if you want calls to go to the headset.

To turn off the acoustic alert, click **Preferences**, then **Audio**. Scroll down to the **Auto Answer** section and click the on/off toggle of **Auto Answer Indication** to **off**.

Active calls

Hold

One call on hold

Press Hold or  to put the ongoing call on hold. Held calls are indicated as follows:

- By the text on the display.
- By the slowly blinking line key.
- By the slowly blinking call indication LED.
- By the double beep when you put a call on hold.

You can now:

- transfer the held call blindly or with prior announcement - see "Transferring calls" on page 24.
- receive and make calls and put other calls on hold.

Pick up the held call by pressing its line key or by pressing  again. If the other party hangs up while on hold, the call is terminated on your phone as well, and the LED indicators are turned off.

Holding multiple calls

The status lines at the top of the display indicate the number of calls on your phone.



Two calls, one active, one on hold.

Two calls, both on hold.

Press \wedge / \vee to scroll through the calls. Your input on the phone's keys will affect the call on the display. It can be resumed, terminated, or selected for conference setup.

Conference

The maximum number of participants in phone-based conferences is five (you and four others).

Note: This section refers to phone-based conferences. For the number of participants in server-based conferences and how to set up and join them, please check with your network administrator or your VoIP provider.

Initiating a conference

1. With a call on the line, press **Conference**. The call is put on hold.
2. Dial the number and announce the conference
3. Press **Join**.
4. Press **End call** to terminate the conference.

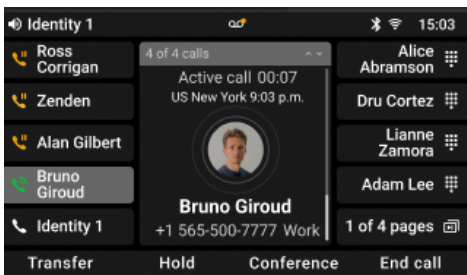

If you have a SmartLabel key set up to speed dial a number, you can blindly add that party to the conference.

1. With a call on the line, press **Conference**. The call is put on hold.
2. Press **Blind conf**.
3. Press the SmartLabel key to start the conference.
 - Putting the conference on hold: press **Hold**. Press **Resume** to restart the conference.
 - Press **Details** to open the interactive screen. Use \wedge / \vee on the navigation key to select individual participants or the conference. Your input on the phone's keys will affect the highlighted participant or the entire conference.
 - You can mute or remove the highlighted individual participant.
 - You can end or split the highlighted conference.

Call waiting while in a conference.

- Press **Reject** (possible only if maximum number of participants is not exceeded)
- Press **Answer**. The conference will be put on hold. Press **Add** to add the caller to the conference.

Transferring calls

You can transfer connected calls as well as calls ringing on your phone.

When you have a call on the line, there are two ways to transfer it to a third party:

- Announcing the call to the third party first, to make sure the call is welcome and will be accepted: **attended transfer**.
- Transferring the call unannounced: **blind transfer**. There will be no feedback on whether the third party is available and/or picking up the call.

When a call is ringing on your phone, you can transfer it to a third party without answering it first (blind transfer only).

Attended transfer**With a single call on the phone.**

1. Press **Transfer**.
2. On the **Xfer setup** screen, enter the number manually or select a number from the phone's call lists.
3. Press **Dial**, putting the active call on hold.
4. If the third party agrees to accept the call, press **Transfer**. The call is transferred.
5. If the third does not want to take the call, press **Cancel**, then **Resume** to resume the held call.

With more than one call. The active call will be transferred. If the active call is not the one you want to transfer, put it on hold, select the other call with \wedge / \vee and press Transfer.

1. On the **Xfer setup** screen, enter the number or select a call from the phone's call list.
2. Press **Dial**.
3. If the third party agrees to accept the call, press **Transfer**. The call is transferred.
4. The remaining call on hold or the first of the remaining calls on hold will then appear on-screen.

Blind transfer**Blind transfer of active call**

1. With a call on the line, press **Transfer**. The **Xfer setup** screen appears.
2. Press **Blind xfer**.
3. Enter the number or select a call from the phone's call list.
4. Press **Blind xfer**. The display shows the message **Call ended** while the call is ringing on the

third party's phone.

Blind transfer of call waiting



1. If you are in a call and want to transfer a call waiting, press **Forward** with the incoming call on the display.
2. On the **Forward call** screen, enter the number or select a call from the phone's call list.
3. Press **Forward**. The display shows the message **Call terminated** while the call is ringing on the third party's phone.

Note: Your active call remains active while you are transferring the ringing call.

Blind transfer of ringing call

1. With a call ringing, press **Forward**.
2. On the **Forward call** screen, enter the number manually or select a number from the phone's call list.
3. Press **Forward**. The display shows the message **Call terminated** while the call is ringing on the third party's phone.

Terminating calls

- When using the handset: place the handset in the cradle or press **End call** or .
- When using speakerphone or a headset: press **End call** or .

Call lists

Four call lists of missed, dialed, received, and all calls are stored on the phone. They contain the number, name (if available), and the time (if the same day) or date of the calls. If the memory allotted to storing the call lists is full, the oldest ones will be overwritten. You can view all calls in the list of all calls, sorted by date and time.

1. Press **Menu**.
2. Select **Applications**.
3. Select **Call history**.
4. Select a list with \wedge / \vee and enter the list with \blacktriangleright or .
5. Select a call with \wedge / \vee .
 - You can **dial** or **delete** the call or
 - press **More** and then **Edit dial** to edit the number before dialing or add it to your local contacts.

Software update

Manual update

1. Go to <https://service.snom.com/display/wiki/Firmware+Update+Center>. and find the latest firmware version for your phone.
2. Please read the instructions and release notes before downloading the firmware.
3. Right-click the download link in the **Firmware files** table.
4. Open the phone manager and click **Maintenance**.
5. Click **Software update**.
6. Enter the phone number in the text field under **Firmware**.
7. Click **Load**.
8. **DO NOT DISCONNECT THE POWER WHILE THE PHONE IS REBOOTING!**

Auto provisioning

For more information, see our web page <https://service.snom.com/display/wiki/Auto+Provisioning>.

1. Open the phone manager and click **Maintenance**.
2. Click **Provision**.
3. Click the individual settings for their details.
4. When done, click **Apply**.

SRAPS

If you are using Snom's Secure Redirection and Provisioning Service (SRAPS), you can log in to your account via the link in the right lateral of the phone's **Home** page. For more information on SRAPS, see <https://service.snom.com/display/wiki/SRAPS>.

Troubleshooting

Contacting Snom Support

If you are not a Snom partner, please contact your seller or consult our troubleshooting knowledge base at <https://service.snom.com/display/wiki/Troubleshooting+How-to> first. You may find the answer to your question or problem in one of the topics there.

Submitting a ticket

If you are a Snom partner, log in to the Snom Partner Portal at <https://sraps.snom.com/partner> and open a ticket.

Submitting system and settings information

System information

1. Open the phone's web interface > **System Information** page.
2. Copy the text under System Information into the email, if Support has asked you to contact them by email.

Settings information

1. Open the phone's web interface > Settings page.
2. Copy the settings list into the email, if Support has asked you to contact them by email.

Traces

Snom Support may ask you to submit a SIP Trace and/or a PCAP Trace to help them analyze your problem.

Performing a SIP Trace

1. Open the Phone Manager and click **Maintenance**.
2. Click **Diagnostic**.
3. Click the **SIP Trace** tab.
4. Click **Clear** to clear the page.
5. Recreate the error to be documented in the trace.
6. Click **Copy**.
7. Submit to Support in whatever form they requested you to use.

Performing a PCAP Trace

1. Open the Phone Manager and click **Maintenance**.
2. Click **Diagnostic**.
3. Click the **PCAP Trace** tab.
4. Click **Start** to start recording network traffic.
5. Click **Stop** to end recording
6. Click **Save** to save the file to your **Download** folder.
7. Submit the file to Support in whatever way they requested you to use.

Appendix 1 - GNU General Public License

COPYRIGHT NOTICE AND WARRANTY DISCLAIMER

I.

This Product contains Software applicable to GNU General Public License, Version 2 which can be used freely.

II.

Towards the licensor of this Software the following liability is disclaimed:

This program is distributed in the hope that it will be useful, but WITHOUT ANY WARRANTY; without even the implied warranty of MERCHANTABILITY or FITNESS FOR A PARTICULAR PURPOSE. See the GNU General Public License for more details.

III.

The GNU General Public License is as follows:

GNU GENERAL PUBLIC LICENSE

Version 2, June 1991

Copyright (C) 1989, 1991
Free Software Foundation, Inc.
59 Temple Place, Suite 330
Boston, MA 02111-1307, USA

Everyone is permitted to copy and distribute verbatim copies of this license document, but changing it is not allowed.

Preamble

The licenses for most software are designed to take away your freedom to share and change it. By contrast, the GNU General Public License is intended to guarantee your freedom to share and change free software--to make sure the software is free for all its users. This General Public License applies to most of the Free Software Foundation's software and to any other program whose authors commit to using it. (Some other Free Software Foundation software is covered by the GNU Library General Public License instead.) You can apply it to your programs, too.

When we speak of free software, we are referring to freedom, not price. Our General Public Licenses are designed to make sure that you have the freedom to distribute copies of free software (and charge for this service if you wish), that you receive source code or can get it if you want it, that you can change the software or use pieces of it in new free programs; and that you know you can do these things.

To protect your rights, we need to make restrictions that forbid anyone to deny you these rights or to ask you to surrender the rights. These restrictions translate to certain responsibilities for you if you distribute copies of the software, or if you modify it. For example, if you distribute copies of such a program, whether gratis or for a fee, you must give the recipients all the rights that you have. You must make sure that they, too, receive or can get the source code. And you must show them these terms so they know their rights.

We protect your rights with two steps: (1) copyright the software, and (2) offer you this license which gives you legal permission to copy, distribute and/or modify the software.

Also, for each author's protection and ours, we want to make certain that everyone understands that there is no warranty for this free software. If the software is modified by someone else and passed on, we want its recipients to know that what they have is not the original, so that any problems introduced by others will not reflect on the original authors' reputations.

Finally, any free program is threatened constantly by software patents. We wish to avoid the danger that redistributors of a free program will individually obtain patent licenses, in effect making the program proprietary. To prevent this, we have made it clear that any

patent must be licensed for everyone's free use or not licensed at all.

The precise terms and conditions for copying, distribution and modification follow.

GNU GENERAL PUBLIC LICENSE

TERMS AND CONDITIONS FOR COPYING, DISTRIBUTION AND MODIFICATION

0. This License applies to any program or other work which contains a notice placed by the copyright holder saying it may be distributed under the terms of this General Public License. The "Program", below, refers to any such program or work, and a "work based on the Program" means either the Program or any derivative work under copyright law: that is to say, a work containing the Program or a portion of it, either verbatim or with modifications and/or translated into another language. (Hereinafter, translation is included without limitation in the term "modification".) Each licensee is addressed as "you". Activities other than copying, distribution and modification are not covered by this License; they are outside its scope. The act of running the Program is not restricted, and the output from the Program is covered only if its contents constitute a work based on the Program (independent of having been made by running the Program). Whether that is true depends on what the Program does.

1. You may copy and distribute verbatim copies of the Program's source code as you receive it, in any medium, provided that you conspicuously and appropriately publish on each copy an appropriate copyright notice and disclaimer of warranty; keep intact all the notices that refer to this License and to the absence of any warranty; and give any other recipients of the Program a copy of this License along with the Program. You may charge a fee for the physical act of transferring a copy, and you may at your option offer warranty protection in exchange for a fee.

2. You may modify your copy or copies of the Program or any portion of it, thus forming a work based on the Program, and copy and distribute such modifications or work under the terms of Section 1 above, provided that you also meet all of these conditions:

a) You must cause the modified files to carry prominent notices stating that you changed the files and the date of any change.

b) You must cause any work that you distribute or publish, that in whole or in part contains or is derived from the Program or any part thereof, to be licensed as a whole at no charge to all third parties under the terms of this License.

c) If the modified program normally reads commands interactively when run, you must cause it, when started running for such interactive use in the most ordinary way, to print or display an announcement including an appropriate copyright notice and a notice that there is no warranty (or else, saying that you provide a warranty) and that users may redistribute the program under these conditions, and telling the user how to view a copy of this License. (Exception: if the Program itself is interactive but does not normally print such an announcement, your work based on the Program is not required to print an announcement.)

These requirements apply to the modified work as a whole. If identifiable sections of that work are not derived from the Program, and can be reasonably considered independent and separate works in themselves, then this License, and its terms, do not apply to those sections when you distribute them as separate works. But when you distribute the same sections as part of a whole which is a work based on the Program, the distribution of the whole must be on the terms of this License, whose permissions for other licensees extend to the entire whole, and thus to each and every part regardless of who wrote it.

Thus, it is not the intent of this section to claim rights or contest your rights to work written entirely by you; rather, the intent is to exercise the right to control the distribution of derivative or collective works based on the Program. In addition, mere aggregation of another work not based on the Program with the Program (or with a work based on the Program) on a volume of a

storage or distribution medium does not bring the other work under the scope of this License.

3. You may copy and distribute the Program (or a work based on it, under Section 2) in object code or executable form under the terms of Sections 1 and 2 above provided that you also do one of the following:

- a) Accompany it with the complete corresponding machine-readable source code, which must be distributed under the terms of Sections 1 and 2 above on a medium customarily used for software interchange; or,
- b) Accompany it with a written offer, valid for at least three years, to give any third party, for a charge no more than your cost of physically performing source distribution, a complete machine-readable copy of the corresponding source code, to be distributed under the terms of Sections 1 and 2 above on a medium customarily used for software interchange; or,
- c) Accompany it with the information you received as to the offer to distribute corresponding source code. (This alternative is allowed only for noncommercial distribution and only if you received the program in object code or executable form with such an offer, in accord with Subsection b above.)

The source code for a work means the preferred form of the work for making modifications to it. For an executable work, complete source code means all the source code for all modules it contains, plus any associated interface definition files, plus the scripts used to control compilation and installation of the executable. However, as a special exception, the source code distributed need not include anything that is normally distributed (in either source or binary form) with the major components (compiler, kernel, and so on) of the operating system on which the executable runs, unless that component itself accompanies the executable.

If distribution of executable or object code is made by offering access to copy from a designated place, then offering equivalent access to copy the source code from the same place counts as distribution of the source code, even though third parties are not compelled to copy the source along with the object code.

4. You may not copy, modify, sublicense, or distribute the Program except as expressly provided under this License. Any attempt otherwise to copy, modify, sublicense or distribute the Program is void, and will automatically terminate your rights under this License. However, parties who have received copies, or rights, from you under this License will not have their licenses terminated so long as such parties remain in full compliance.

5. You are not required to accept this License, since you have not signed it. However, nothing else grants you permission to modify or distribute the Program or its derivative works. These actions are prohibited by law if you do not accept this License. Therefore, by modifying or distributing the Program (or any work based on the Program), you indicate your acceptance of this License to do so, and all its terms and conditions for copying, distributing or modifying the Program or works based on it.

6. Each time you redistribute the Program (or any work based on the Program), the recipient automatically receives a license from the original licensor to copy, distribute or modify the Program subject to these terms and conditions. You may not impose any further restrictions on the recipients' exercise of the rights granted herein. You are not responsible for enforcing compliance by third parties to this License.

7. If, as a consequence of a court judgment or allegation of patent infringement or for any other reason (not limited to patent issues), conditions are imposed on you (whether by court order, agreement or otherwise) that contradict the conditions of this License, they do not excuse you from the conditions of this License. If you cannot distribute so as to satisfy simultaneously your obligations under this License and any other pertinent obligations, then as a

consequence you may not distribute the Program at all. For example, if a patent license would not permit royalty-free redistribution of the Program by all those who receive copies directly or indirectly through you, then the only way you could satisfy both it and this License would be to refrain entirely from distribution of the Program.

If any portion of this section is held invalid or unenforceable under any particular circumstance, the balance of the section is intended to apply and the section as a whole is intended to apply in other circumstances.

It is not the purpose of this section to induce you to infringe any patents or other property right claims or to contest validity of any such claims; this section has the sole purpose of protecting the integrity of the free software distribution system, which is implemented by public license practices. Many people have made generous contributions to the wide range of software distributed through that system in reliance on consistent application of that system; it is up to the author/donor to decide if he or she is willing to distribute software through any other system and a licensee cannot impose that choice. This section is intended to make thoroughly clear what is believed to be a consequence of the rest of this License.

8. If the distribution and/or use of the Program is restricted in certain countries either by patents or by copyrighted interfaces, the original copyright holder who places the Program under this License may add an explicit geographical distribution limitation excluding those countries, so that distribution is permitted only in or among countries not thus excluded. In such case, this License incorporates the limitation as if written in the body of this License.

9. The Free Software Foundation may publish revised and/or new versions of the General Public License from time to time. Such new versions will be similar in spirit to the present version, but may differ in detail to address new problems or concerns. Each version is given a distinguishing version number. If the Program specifies a version number of this License which applies to it and „any later version“, you have the option of following the terms and conditions either of that version or of any later version published by the Free Software Foundation. If the Program does not specify a version number of this License, you may choose any version ever published by the Free Software Foundation.

10. If you wish to incorporate parts of the Program into other free programs whose distribution conditions are different, write to the author to ask for permission. For software which is copyrighted by the Free Software Foundation, write to the Free Software Foundation; we sometimes make exceptions for this. Our decision will be guided by the two goals of preserving the free status of all derivatives of our free software and of promoting the sharing and reuse of software generally.

NO WARRANTY

11. BECAUSE THE PROGRAM IS LICENSED FREE OF CHARGE, THERE IS NO WARRANTY FOR THE PROGRAM, TO THE EXTENT PERMITTED BY APPLICABLE LAW. EXCEPT WHEN OTHERWISE STATED IN WRITING THE COPYRIGHT HOLDERS AND/OR OTHER PARTIES PROVIDE THE PROGRAM „AS IS“ WITHOUT WARRANTY OF ANY KIND, EITHER EXPRESSED OR IMPLIED, INCLUDING, BUT NOT LIMITED TO, THE IMPLIED WARRANTIES OF MERCHANTABILITY AND FITNESS FOR A PARTICULAR PURPOSE. THE ENTIRE RISK AS TO THE QUALITY AND PERFORMANCE OF THE PROGRAM IS WITH YOU. SHOULD THE PROGRAM PROVE DEFECTIVE, YOU ASSUME THE COST OF ALL NECESSARY SERVICING, REPAIR OR CORRECTION.

12. IN NO EVENT UNLESS REQUIRED BY APPLICABLE LAW OR AGREED TO IN WRITING WILL ANY COPYRIGHT HOLDER, OR ANY OTHER PARTY WHO MAY MODIFY AND/OR REDISTRIBUTE THE PROGRAM AS PERMITTED ABOVE, BE LIABLE TO YOU FOR DAMAGES, INCLUDING ANY GENERAL, SPECIAL, INCIDENTAL OR CONSEQUENTIAL DAMAGES ARISING OUT OF THE USE OR INABILITY TO USE THE PROGRAM (INCLUDING BUT NOT LIMITED TO LOSS OF DATA OR DATA BEING RENDERED INACCURATE OR LOSSES SUSTAINED BY YOU OR THIRD PARTIES OR A FAILURE OF THE PROGRAM TO OPERATE WITH ANY OTHER PROGRAMS), EVEN IF SUCH HOLDER OR OTHER PARTY HAS BEEN ADVISED OF THE

POSSIBILITY OF SUCH DAMAGES.

END OF TERMS AND CONDITIONS

How to Apply These Terms to Your New Programs

If you develop a new program, and you want it to be of the greatest possible use to the public, the best way to achieve this is to make it free software which everyone can redistribute and change under these terms.

To do so, attach the following notices to the program. It is safest to attach them to the start of each source file to most effectively convey the exclusion of warranty; and each file should have at least the "copyright" line and a pointer to where the full notice is found.

<one line to give the program's name and a brief idea of what it does>Copyright (C) <year> <name of author>

This program is free software; you can redistribute it and/or modify it under the terms of the GNU General Public License as published by the Free Software Foundation; either version 2 of the License, or (at your option) any later version.

This program is distributed in the hope that it will be useful, but WITHOUT ANY WARRANTY; without even the implied warranty of MERCHANTABILITY or FITNESS FOR A PARTICULAR PURPOSE. See the GNU General Public License for more details.

You should have received a copy of the GNU General Public License along with this program; if not, write to the Free Software Foundation, Inc., 59 Temple Place, Suite 330, Boston, MA 02111-1307 USA

IV.

If requested by you, the complete corresponding source code of the Software can be sent by Snom Technology GmbH on a standard data storage medium against the reimbursement of the manufacturing costs of EUR 10.- per unit.

The complete corresponding source code of the Software can also be downloaded from our web site <https://www.snom.com/en/footer/discover-snom/gtc/source-code-gpl-open-source/>.

V.

For further information see <http://www.snom.com>.

Snom Technology GmbH
Wittestr. 30 G
13509 Berlin, Deutschland
office.de@snom.com

Snom Technology GmbH
Via Milano 1
20020 Lainate, Italia
office.it@snom.com

Snom Technology GmbH
The Courtyard, High Street
Ascot, Berkshire SL5 7HP, UK
office.uk@snom.com

Snom Technology GmbH
130 avenue Joseph Kessel
78960 Voisins-le-Bretonneux, France
office.fr@snom.com

VTech Communications Inc.
Snom Americas
9020 SW Washington Square Road,
Suite 555
Tigard, OR 97223
U.S.A.

VTech Technologies Canada Ltd.
Suite 222
12888 Wireless Way
Richmond, B.C. V6V 0A3
Canada

Manufacturer:

VTech Telecommunications Ltd.
23/F., Tai Ping Industrial Centre, Block 1,
57 Ting Kok Road, Tai Po
HONG KONG

Your specialist retailer:

•

•

•

•