

snom



User Manual  
IP Phone D862

## TABLE OF CONTENTS

<b>Copyright, Trademarks, GPL, Legal Disclaimers</b> .....	<b>6</b>
<b>Important information</b> .....	<b>7</b>
Safety instructions .....	7
Standards conformance .....	8
Product specifications .....	9
Disposal of the device .....	9
Cleaning .....	9
<b>Setting up the phone</b> .....	<b>10</b>
Delivery Content .....	10
Attaching footstand and handset .....	10
Wall mounting .....	11
Rotating the tab of the cradle .....	11
Connecting the phone .....	12
Removing the protective film from the display .....	13
Tiltable display .....	13
Connecting a headset .....	13
Initializing and registering the phone .....	14
Prerequisites .....	14
Initialization .....	15
What to do if initialization and registration are unsuccessful .....	16
Correcting the clock .....	16
<b>Getting to know your phone</b> .....	<b>18</b>
At a glance .....	18
LED indicators .....	20
Hard keys .....	21
Context-sensitive, programmable function keys .....	21
Navigation, confirmation, and cancel keys .....	21
Preprogrammed, variably programmable function keys .....	21
Audio control keys .....	22
SmartLabel keys (freely programmable function keys with LEDs) .....	22
Alphanumeric Keypad .....	22
Input modes and navigation .....	22
Entering numerals, letters, special characters, and symbols .....	23
Ambient light sensor .....	24
Display layout .....	24
In idle mode .....	24
When the phone is active .....	26

User mode/administrator mode .....	26
User names and passwords .....	26
Setting administrator name and PIN .....	27
Setting HTTP user name and password .....	27
Setting user/admin mode on the phone .....	28
Settings .....	28
Settings available in user mode .....	28
Settings available in administrator mode .....	28
The phone's web interface .....	30
How the web interface works .....	30
<b>Directories .....</b>	<b>32</b>
Directory .....	32
Definitions, explanations .....	32
Directory entries .....	32
Contact Types .....	33
Outgoing identity .....	33
Group .....	33
Ringtones .....	33
Adding/editing entries on the legacy web interface .....	34
Adding new entry .....	34
Editing an entry .....	35
Deleting entry on web interface .....	36
Dialing from phone directory .....	36
Deleting whole directory .....	36
Importing/exporting a directory .....	36
External directories .....	37
LDAP .....	37
Contacts .....	37
<b>Using the phone .....</b>	<b>39</b>
Making calls .....	39
Selecting identity for current outgoing call .....	39
Using different audio devices .....	39
Handset .....	39
Headset .....	39
Speakerphone .....	39
Using different dialing methods .....	39
Auto dial .....	39
Redialing .....	40
Calling number from call history (missed, received, dialed calls) .....	40
Calling number from a directory .....	40

Speed dialing .....	41
Calling emergency numbers .....	41
Call completion .....	41
QuickLookup (number guessing/auto completion) .....	42
Accepting calls .....	43
Using different audio devices .....	43
Automatically accepting calls .....	43
Call pick-up from another extension .....	43
Call waiting .....	44
Active calls .....	45
Hold .....	45
Conference .....	45
Transferring calls .....	46
Attended transfer .....	46
Blind transfer .....	47
Terminating calls .....	48
Missed calls .....	48
Call lists .....	48
Locking and unlocking the keyboard .....	49
Rejecting or redirecting incoming calls .....	49
Manually .....	49
Automatically .....	49
Rejecting anonymous calls .....	50
Call forwarding .....	50
<b>Configuring the function keys .....</b>	<b>52</b>
Function key types on Snom phones .....	52
Display options for SmartLabel keys .....	54
Programming the function keys .....	55
Context-sensitive keys .....	55
SmartLabel keys (PFK) .....	55
Configuring the functions on the Phone Manager web interface .....	56
Selected examples for function key programming .....	56
Example 1, Extension monitoring and call pick-up .....	57
Example 2, Speed dialing .....	58
Example 3, Changing setting of context-sensitive key .....	59
<b>Customizing the phone settings .....</b>	<b>60</b>
Identities/accounts .....	60
Configuring and editing identity/account .....	60
Assigning ringtones .....	62



Date and time formats .....	63
Time zone .....	63
Language settings of phone and web interface .....	64
Dial tones .....	65
Emergency numbers .....	65
Keyboard locking .....	65
Call forwarding .....	66
Call completion .....	67
Call waiting .....	67
Hiding my caller ID .....	68
Rejecting anonymous calls .....	68
Speed dial .....	68
Auto dial .....	69
Auto dial target .....	70
<b>Software update .....</b>	<b>71</b>
Manual update .....	71
Auto provisioning .....	71
SRAPS .....	71
<b>Troubleshooting .....</b>	<b>72</b>
Reboot .....	72
Hard reboot .....	72
Reset to factory values .....	72
TFTP Update .....	72
Manual initialization .....	73
Contacting Snom Support .....	73
Traces .....	73
<b>Appendix 1 - Display Symbols and Icons .....</b>	<b>75</b>
Symbols found in the function key line .....	75
SmartLabel function symbols .....	77
Favicons .....	80
<b>Appendix 2 - Wall mounting.....</b>	<b>81</b>
<b>Appendix 3 - Programmable Functions .....</b>	<b>83</b>
Freely programmable functions .....	83
Key Events .....	86
<b>Appendix 4 - GNU General Public License.....</b>	<b>89</b>

# Copyright, Trademarks, GPL, Legal Disclaimers

© 2023 Snom Technology GmbH

All Rights Reserved.

Snom, the names of Snom products, and Snom logos are trademarks owned by Snom Technology GmbH. All other product names and names of enterprises are the property of their respective owners.

Product specifications are subject to change without notice.

Snom Technology GmbH reserves the right to revise and change this document at any time, without being obliged to announce such revisions or changes beforehand or after the fact.

Texts, images, and illustrations and their arrangement in this document are subject to the protection of copyrights and other legal rights worldwide. Their use, reproduction, and transmittal to third parties without express written permission may result in legal proceedings in the criminal courts as well as civil courts.

When this document is made available on Snom's web page, Snom Technology GmbH gives its permission to download and print copies of its content for the intended purpose of using it as a manual. No parts of this document may be altered, modified or used for commercial purposes without the express written consent of Snom Technology GmbH.

Although due care has been taken in the compilation and presentation of the information in this document, the data upon which it is based may have changed in the meantime. Snom therefore disclaims all warranties and liability for the accurateness, completeness, and currentness of the information published, except in the case of intention or gross negligence on the part of Snom or where liability arises due to binding legal provisions.

Our firmware includes some source code that may be used and modified by anyone and everyone under the GNU Public License (GPL) (see "Appendix 4 - GNU General Public License" on page 89), provided they, in turn, make it available to everyone else with the same licensing agreement. Please go to <https://www.snom.com/en/footer/discover-snom/gtc/source-code-gpl-open-source/> for the original GPL license and the source code of components licensed under GPL and used in Snom products.

## Important information

Please read the instructions on safety and disposal and on how to set up and use the device before using it and also give them to other users to read or inform those users of their contents. Save this manual and do not give the device to third parties without it.

## Safety instructions

Follow the instructions in this manual and other applicable documentation of the device.

- This device is designed for professional use.
- **Warning:** Changes or modifications to this unit not expressly approved by the party responsible for compliance could void the user's authority to operate the equipment.
- **Warning:** The product included (ITE) in this manual is to be connected only to PoE networks without routing to the outside plant.
- The socket outlet for the power adaptor must be near the equipment and easily accessible.
- Mount the device only at heights not exceeding 2m.
- Follow the instructions in this manual and other applicable documentation of the device.
- If the phone is not supplied with power via the Ethernet cable, use only a power adapter expressly recommended by Snom Technology. Other power supplies may damage or destroy the phone, affect its behavior, or induce noise.
- Avoid placing the cables where people may trip over them or where they may be exposed to mechanical pressure as this may damage them.
- This device is for indoor use only! NOT FOR OUTDOOR USE!
- Do not install the device in rooms with high humidity (for example, in bathrooms, laundry rooms, damp basements). Do not immerse the device in water and do not spill or pour liquids of any kind onto or into the device.
- Do not install the device in surroundings at risk for explosions (paint shops, for example). Do not use the device if you smell gas or other potentially explosive fumes.
- Do not use the device during thunderstorms. Lightning striking the power grid may cause electric shocks.
- **Warning:** The handset contains a magnet, and its earpiece may attract small dangerous objects such as needles or pins. Please ensure before each use that no such objects are present.
- Safety status of input/output connections comply with SELV (Safety Extra Low Voltage) requirements.
- **Warning:** To avoid electric shock, do not connect safety extra-low voltage (SELV) circuits to telephone-network voltage (TNV) circuits. LAN ports contain SELV circuits, and PSTN ports contain TNV circuits. Some LAN and PSTN ports both use RJ-45 (8P8C) connectors. Use caution when connecting cables.
- SELV (Safety Extra Low Voltage) compliance. Safety status of input/output connections comply with SELV requirements.

**Warning:** To avoid electric shock, do not connect safety extra-low voltage (SELV) circuits to telephone-network voltage (TNV) circuits. LAN ports contain SELV circuits, and PSTN ports contain

TNV circuits. Some LAN and PSTN ports both use RJ-45 (8P8C) connectors. Use caution when connecting cables.

## Standards conformance



This device complies with the essential health, safety, and environmental requirements of all relevant European directives and UK legislation. The declaration of conformity can be downloaded at <https://www.snom.com/conformity>.

You can download the declaration of conformity at [www.snom.com/conformity](http://www.snom.com/conformity).

This product meets the applicable Innovation, Science and Economic Development Canada technical specifications.

This phone is FCC Class A verified and meets US health, safety, and environmental standards.

Unauthorized opening, changing, or modifying the device will cause the warranty to lapse and may also result in the loss of CE, UKCA, and ISED conformity and the FCC verification. In case of malfunction contact authorized service personnel, your seller, or Snom.

## Additional information U.S.A.

**Note:** This equipment has been tested and found to comply with the limits for a Class A digital device, pursuant to part 15 of the FCC Rules. These limits are designed to provide reasonable protection against harmful interference when the equipment is operated in a commercial environment. This equipment generates, uses, and can radiate radio frequency energy and, if not installed and used in accordance with the instruction manual, may cause harmful interference to radio communications. Operation of this equipment in a residential area is likely to cause harmful interference in which case the user will be required to correct the interference at his own expense.

### Consumer Information

- a. This equipment complies with Part 68 of the FCC rules and the requirements adopted by the ACTA. On the bottom of this equipment is a label that contains, among other information, a product identifier in the format US:AAAEQ##TXXXX. If requested, this number must be provided to the telephone company.
- b. An applicable certification jacks Universal Service Order Codes (USOC) for the equipment is provided (i.e., RJ45C) in the packaging with each piece of approved terminal equipment.
- c. A plug and jack used to connect this equipment to the premises wiring and telephone network must comply with the applicable FCC Part 68 rules and requirements adopted by the ACTA. A compliant LAN cable (RJ45) and modular plug is provided with this product. An RJ45 jack should normally be used for connecting to the SIP equipment through the LAN cable. See installation instructions for details.
- d. If this equipment causes harm to the telephone network, the telephone company will notify you in advance that temporary discontinuance of service may be required. But if advance notice isn't practical, the telephone company will notify the customer as soon as possible. Also, you will be advised of your right to file a complaint with the FCC if you believe it is necessary.
- e. The telephone company may make changes in its facilities, equipment, operations or procedures that could affect the operation of the equipment. If this happens the telephone company will provide advance notice in order for you to make necessary modifications to maintain uninterrupted service.

- f. Should you experience trouble with this equipment, please contact

Snom Technology GmbH  
1 (339) 227-6160 (select option 2)

for repair or warranty information. If the equipment is causing harm to the telephone network, the telephone company may request that you disconnect the equipment until the problem is resolved.

- g. Please follow instructions for repairing if any (e.g. battery replacement section); otherwise do not alternate or repair any parts of device except specified.
- h. Connection to party line service is subject to state tariffs. Contact the state public utility commission, public service commission or corporation commission for information.
- i. **NOTICE:** If your home has specially wired alarm equipment connected to the telephone line, ensure the installation of this device does not disable your alarm equipment. If you have questions about what will disable alarm equipment, consult your telephone company or a qualified installer.
- j. This equipment is hearing aid compatible.

**NOTICE:** According to telephone company reports, AC electrical surges, typically resulting from lightning strikes, are very destructive to telephone equipment connected to AC power sources. To minimize damage from these types of surges, a surge arrestor is recommended.

## Product specifications

- **Safety:** IEC 62368-1
- **Connectors:**
  - 2 x RJ45 (Ethernet): 1 x LAN, 1 x PC
  - 2 x 4P4C (handset, optional headset)
  - 1 x RJ12
  - USB port: 1 x type A, USB 2.0
- **Ethernet:** 2 x IEEE 802.3 / 1 Gigabit Ethernet switch
- **Power.** Power over Ethernet (PoE), IEEE 802.3af, Class 3. If PoE is not available, one of the following power adapters (not included in delivery) can be ordered separately:
  - Mass Power, model NBS12E050200UV, Snom PN 00004570 (EU, U.S.)
  - Rongweixin, model R122-0502000ID, Snom PN 00004571 (U.S.)

## Disposal of the device



This device is subject to European Directive 2012/19/EU and may not be disposed of with general household garbage. If you do not know where you may dispose of the device at the end of its lifespan, contact your municipality, your local waste management provider, or your seller.

## Cleaning

To clean the device, use an anti-static cloth. Please avoid cleaning liquids as they might damage the surface or internal electronics of the device.

## Setting up the phone

### Delivery Content

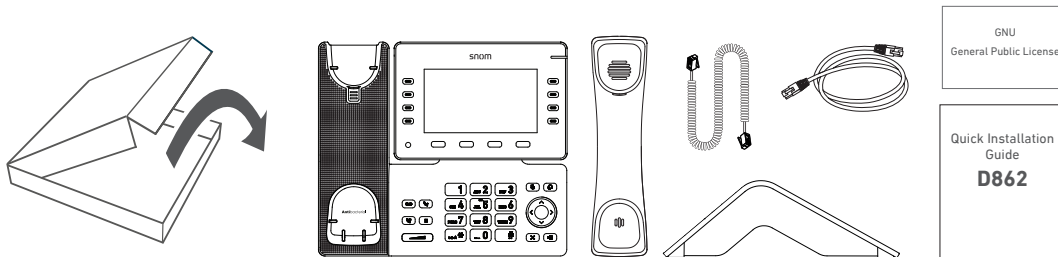

- Base phone unit
- Footstand
- Handset
- Handset cord
- Ethernet cable
- Quick Installation Guide, GNU General Public Licence

### Attaching footstand and handset

**Note:** Before attaching the footstand to the phone, plug the long end of the handset cord into the connector labelled "☞" on the back of the phone and place the cord in the cable guide.

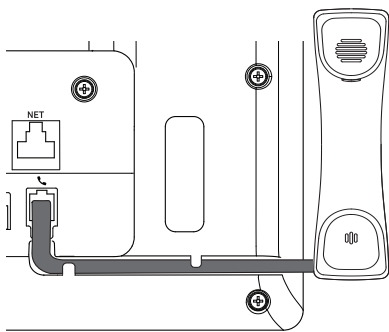

1. Place the top of the grooves on the footstand below the slideguides on the back of the phone.
2. Push the footstand upwards onto the slideguides until it locks into place.

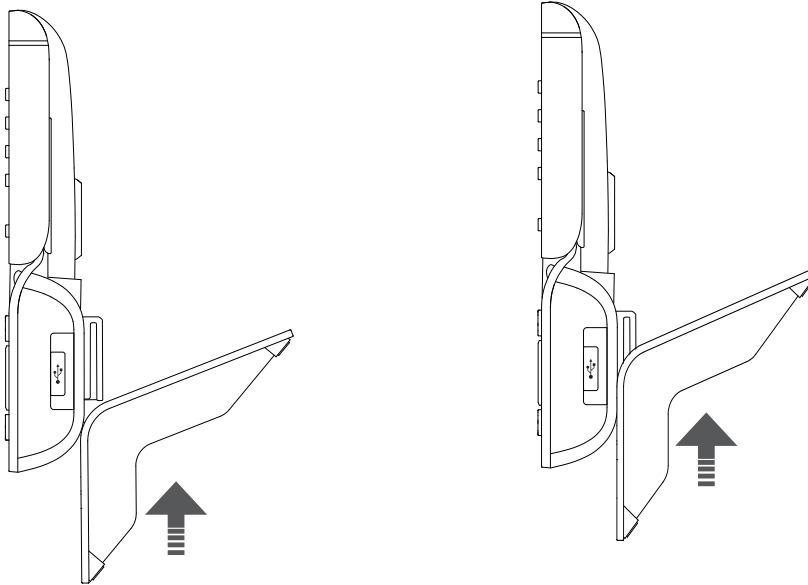

3. Plug the short end of the handset cord into the connector on the handset.
4. Place the phone on an even, horizontal surface.

## Wall mounting

The bracket for wall mounting is available separately. Contact your seller for more information. For information on how to attach the bracket and mount the phone on the wall see "Appendix 2 - Wall mounting" on page 81 .

## Rotating the tab of the cradle

The phone is delivered with the tab level with the inner edge of the cradle. If you are going to mount the phone on a wall, we recommend that you rotate the tab 180°. After rotation, the tip of the tab will protrude slightly above the edge of the "cradle". The small rectangular hole in the receiver casing fits perfectly over the now protruding tip, holding the receiver safely in place in the upright position on the wall.

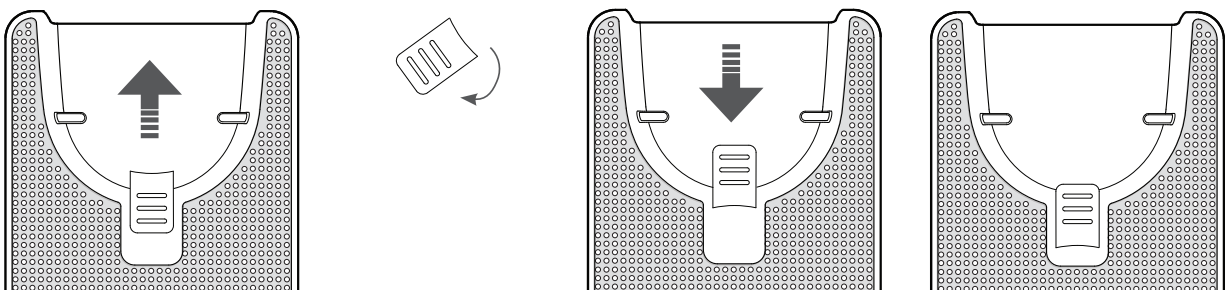

Fig. 1

Fig. 2

Fig. 3

1. Slide the plastic tab from the cradle (Fig. 1)
2. Rotate the tab 180°.
3. Slide the tab back into the cradle (Fig. 2). The top of the tab now protrudes slightly above the inner edge of the cradle (Fig. 3), so that it will hold the handset more securely.

## Connecting the phone

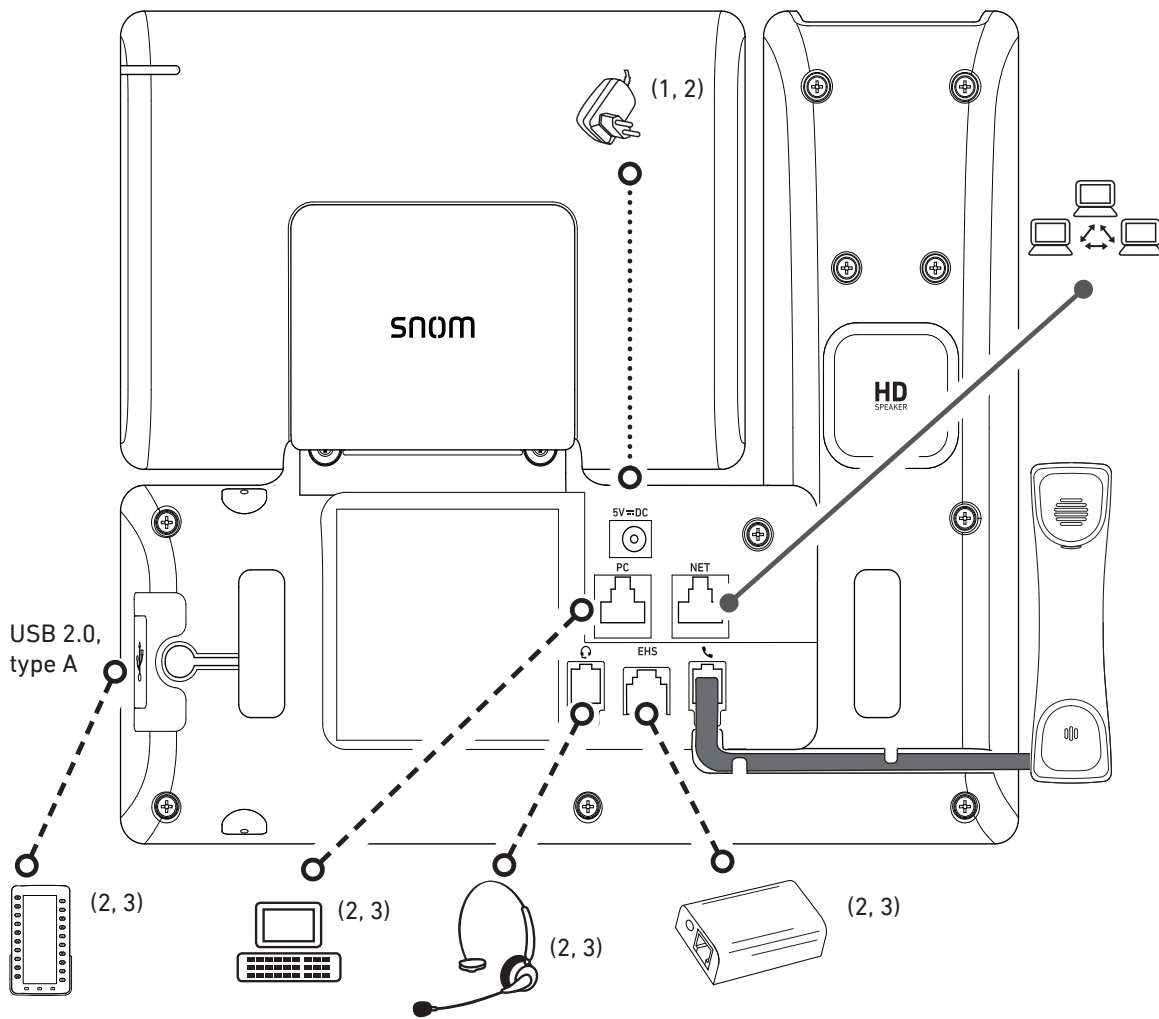

- (1) If PoE not available ●.....●
- (2) Not included in delivery
- (3) Optional ●-----●

The phone can be operated with Power over Ethernet (PoE) provided via the network cable or, if PoE is not available in your network, with the separately available 5V DC power adapter (see "Product specifications" on page 9).

- Plug one end of the Ethernet (network) cable into the RJ45 connector labeled "NET" and the other one into the network side to establish a data link.  
If PoE is not available, insert the plug of the power supply into the connector labeled "5V DC" and hook up the plug to the wall outlet.
- The second RJ45 connector, labeled "PC", is for daisy-chaining further Ethernet devices without the need for a second Ethernet connection line.



## Removing the protective film from the display

The display is covered by a protective film, either by a one-piece or a two-piece film. Gently pull the tab(s) to peel it off.

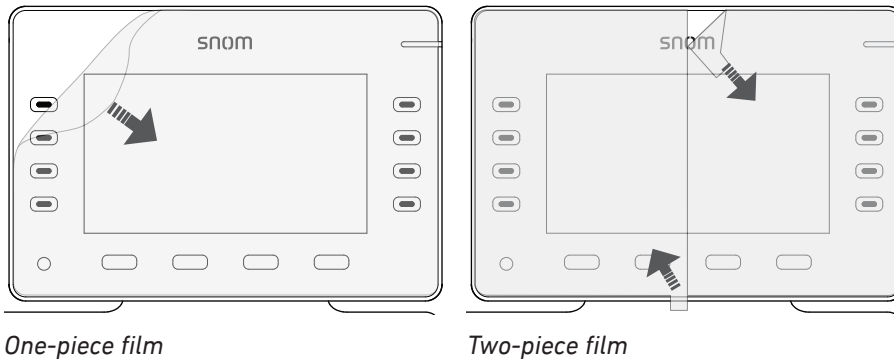

**Note:** The display's cover is held in place magnetically for easy removal when necessary for customization or replacement. If the protective film is peeled off with too much force, the cover may become dislodged from the display. Simply put it back into its proper position.

## Tiltable display

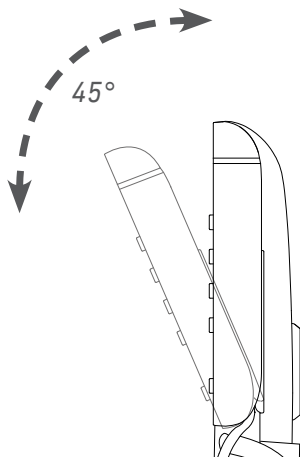

The display angle is adjustable by 45 degrees.

## Connecting a headset

You can use wired as well as wireless headsets with the phone.

- Wired headsets

If you want to use a wired headset, connect it to the RJ audio jack labeled .

**Note:** If both a wired and a wireless headset are connected to the phone, incoming calls will go to the wireless headset.

- Wireless headsets
  - Connecting the base station of your headset via the Snom EHS Adapter.
    1. Connect the plug labeled **D3xx/D785** on the 2xRJ12 cable that came with the Snom EHS Adapter to the jack marked **EHS** on the phone, and the plug labeled **EHS box** to the Snom EHS Adapter's RJ12 jack. For more information, see the illustrated EHS Advanced Quick Installation Guide at <https://service.snom.com>, **Snom products**, **Accessories**, **EHS Wireless Headset Adapter**.
    2. Connect the EHS box to the headset's base station with the 2xRJ45 cable also provided with the Snom Advanced.
    3. Connect the 4P4C/4P4C audio cable that came with the headset to the phone's RJ audio jack labeled . Connect the other end to the headset's base station. For more information, please refer to the headset's user guide.
  - Connecting the headset to the phone via a Bluetooth-compatible adapter.

Insert the adapter into the USB port of the phone. See also the manual of the headset.

**Note:** The default settings for USB headsets are `VID=0a12:PID=100d:HOOK=38/1` for firmware 8.7.2.11 and higher.

If you are using a different headset, enter the parameters of the headset manually on the Phone Manager. Click **Preferences** in the left lateral menu, then **Audio**. Scroll down to the **Advanced** section, **Audio parameters** setting. Click the setting to display the pop-up window with the parameters you need to use for your respective headset.

## Initializing and registering the phone

### Prerequisites

To be able to use VoIP, you or your company must have:

- A broadband internet connection.
- Access to the internet via a router. This could be a separate device available in various versions from many different manufacturers or in the form of a router on a server or a PC.
- Account information provided by your network administrator or a VoIP account with a VoIP service provider who supports the VoIP SIP standard. The phone supports up to 8 VoIP accounts with one or more VoIP providers.

The registration information received from your Internet service provider or your network administrator may differ and may contain required and optional data. The required data normally includes:

- Account (usually the phone number). On Snom phones, an account is called an "identity".
- Registrar
- Password

User name, authentication name, and outbound proxy may also be required. These are settings that can only be configured on the web interface of the phone after it has been successfully registered. If your provider or your network provides a mailbox account, that setting is also configured on the web interface. For more information, see "Identities/accounts" on page 60.

## Initialization

Snom phones are plug-and-play. Once the phone is connected to your network, it will begin to initialize.

**Note:** Normally the initialization is completely automatic, using DHCP. If the phone cannot discover a DHCP server in the subnet, you will be asked: Are you using DHCP? If your network does not support DHCP, press **X** and enter the IP address, netmask, IP gateway, and DNS server manually. Ask your Internet service provider or your network administrator for them.

If your network does not support DHCP, you must obtain the IP address, netmask, IP gateway, and DNS server from your Internet service provider or your network administrator and enter them manually.

When the phone has been connected, it will show the welcome screen with the IP address of the Phone Manager. Enter the IP address into the address bar of your computer's browser and press ENTER to open the Phone Manager.

Welcome to Phone manager!

Please log in with your user credentials.

Username  
Your account username

Password  
Your secret password 

 **Authenticate**

1. Click **Authenticate**. The **Home** page opens.

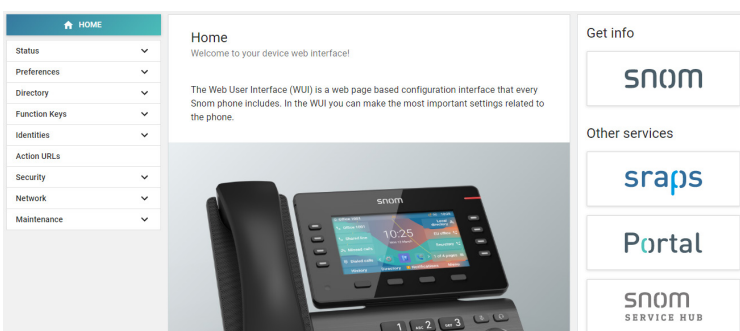

2. Click **Preferences** in the vertical menu on the left side.
3. Select the **language** and click **Apply**,
4. Select the **timezone** and click **Apply**.
5. Select the **tone scheme** (dial tone) and click **Apply**.
6. Click **Identities** in the vertical menu on the left side and select **Profile**.
7. Enter the **account number**, the **registrar**, and the **password** received from your Internet service provider or administrator and click **Apply**.

After successful registration you will see the idle screen with the registered identity in the upper left corner:

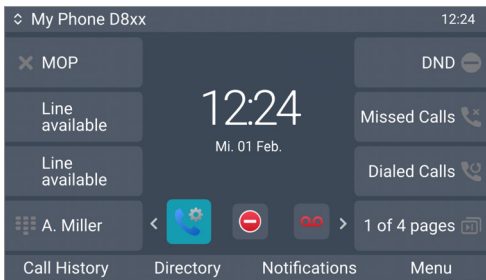

**Note:** If the account is preceded by a red dot  My Phone D8 and the phone is not working, the server may be down, either for servicing or due to a malfunction. Press the key underneath **Notifications** to see details.

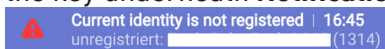

The registration and initialization should be completed as soon as the server is up and running again. You may want to check with your administrator or your provider if nothing happens within a reasonable amount of time.

## What to do if initialization and registration are unsuccessful

Your network or your VoIP provider may require more login data than requested by the Snom phone during the initialization and registration process. This data is entered on the web interface of the phone. Contact your network system administrator or your VoIP provider for more information.

1. When you have received all necessary data, open the phone manager.
2. Open the **profile** of **Identity 1** and enter any additional login information you have received from your provider. See "Identities/accounts" on page 60 for more information.

**Note:** A number of IP telephony service providers and a number of SIP PBXs require settings that are different from Snom's standard factory settings. Snom's web page lists numerous providers and PBXs that have been tested for interoperability with our phones and specific settings that may be required. Do not change the standard configuration unless you know what you are doing. Expert help may be required.

## Correcting the clock

The phone receives the time and date from your NTP time server. If the time and/or date on the display are incorrect, you may need to set the correct time zone in the phone manager.

1. Click **Preferences**, then **Time & Date**.
2. In **Time**, select the timezone from the drop-down menu of **Time Zone** and click **Apply**.

If the time is still incorrect, there may be a problem with the time server. Contact your network administrator or your IP provider.

## Time and date formats

The default settings are 24-hour clock, e.g. 17:35, and U.S. date format MM/DD/YEAR, eg. 11/23/2022. You can change both in the phone manager.

1. Click **Preferences**, then **Appearance**.

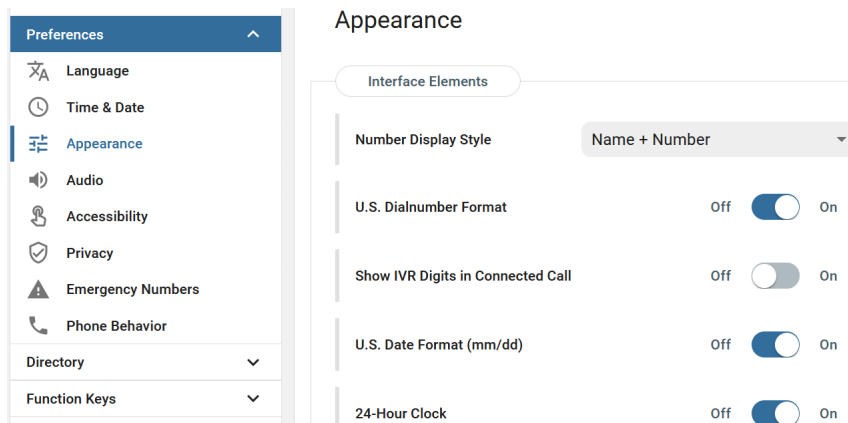

2. Click the slider of **U.S. Date Format** from **On** to **Off** if you want to change the date to the European format DD.MM.YEAR, e.g. 23.11.2022.
3. Click the slider of **24-Hour Clock** from **On** to **Off** if you want to change the time format to the 12-hour AM and PM format.

# Getting to know your phone

## At a glance

The factory settings at a glance:

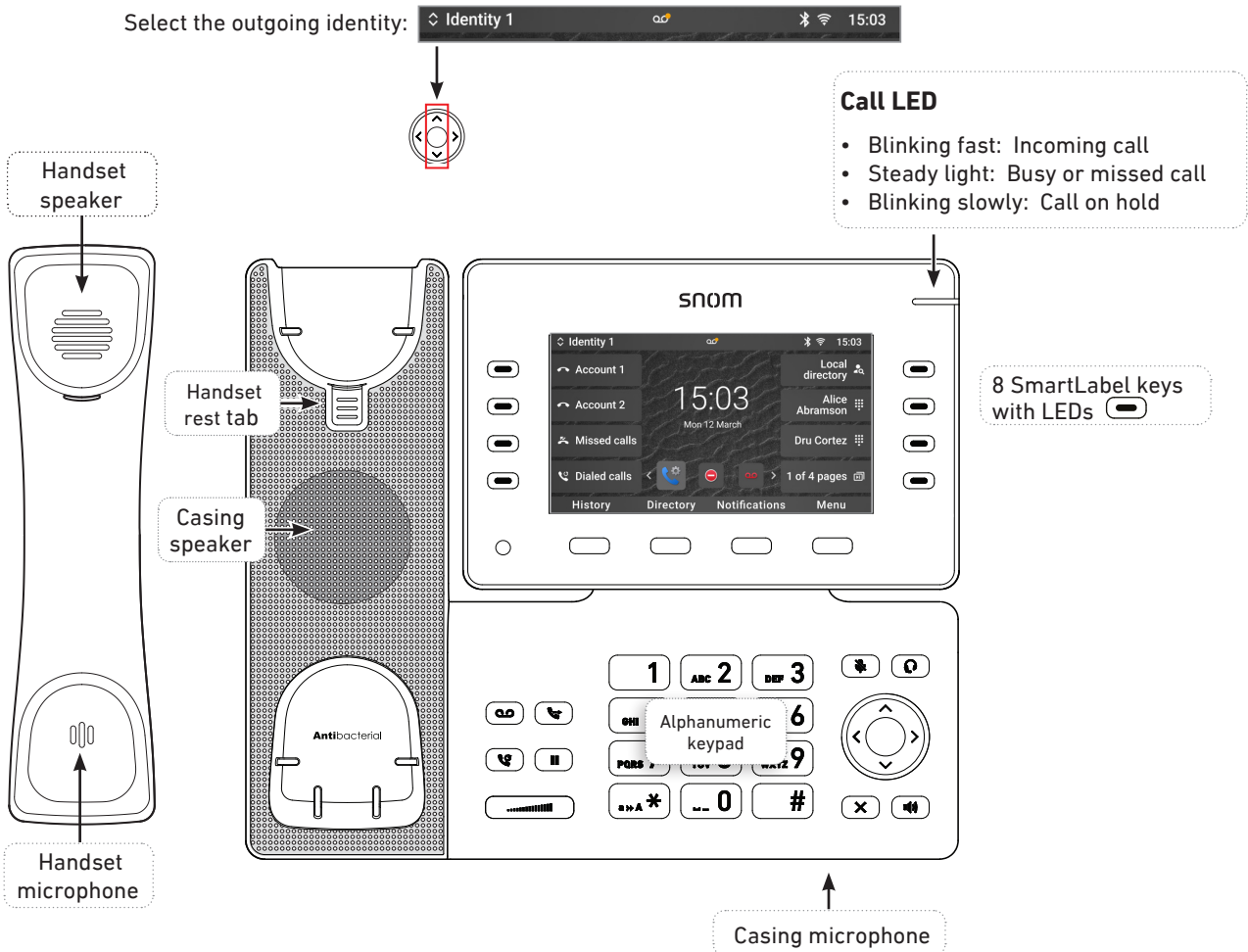

### Context-sensitive, programmable function symbols and function keys F1–F4

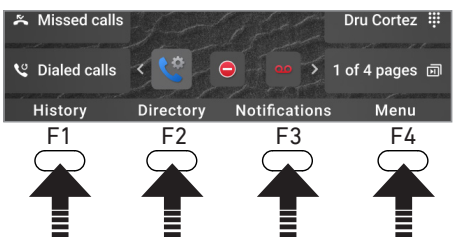





Press the function key underneath the display symbol to activate the function, open the list etc. depicted by the symbol above the key.

Standard functions available on idle screen. Default settings depend on the firmware installed on the phone.

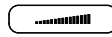
- Directory** Internal phone directory
- History** Call lists (missed, received, dialled calls)
- CFwd** Forwarding all calls (turning CFwd on/off)
- Menu** Settings menu
- Notifications** Status information (call forwarding active, passwords not set, missed calls, etc.)

**Audio control keys**

-  Adjusting the volume
  - of the ringer when the phone is idle or ringing
  - of the handset/casing loudspeaker when in a call
-  Mute/unmute microphone
-  Toggling between handsfree and handset mode. Press to dial number and accept calls on speakerphone.
-  Headset mode on/off

**Navigation keys**

- Canceling actions & input, and returning to previous screen
- Terminating calls on speakerphone and in headset & handset modes

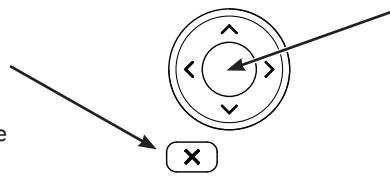

- Confirming, saving actions & input, and returning to previous screen
- Accepting calls on speakerphone and in headset mode
- **From idle screen: call features menu**



**From idle screen:** Select outgoing identity

**In other contexts (settings, lists):** Navigate up/down





**On idle screen:** Select a favicon

**In other contexts:** Navigate/space left

**Favicons — shortcuts to menus**

  
*Preferences*





  
*System*

  
*Call features*

  
*DND*

  
*Mailbox*





**Dedicated, customizable function keys**

-  MWI key with LED
  - LED is lit when message is waiting on mailbox (if mailbox supplied on PBX)
  - Press key to listen to message(s)
-  Redial
-  Transfer
-  Hold

**SmartLabel keys P1–P32, freely programmable, self-labeling, with LEDs** 

Default setting: Line

- Fast-blinking LED: Incoming call. Press blinking key or  to accept
- Steadily lit LED: In call
- Slow-blinking LED: Call on hold

- P1–P8 
- P9–P16 
- P17–P24 
- P25–P32 

Default page keys: P8, P16, P24, P32

1 of 4 pages 

**Star key** 

- **In editing mode:**
  - Press for one second to change input mode (numerals > lower case > upper case)
  - Press briefly to type \*
- **On idle screen:** Press for 3 seconds to **lock/unlock the keypad**

## LED indicators

### Call indicator

The bright-red LED situated on the top right corner of the phone indicates incoming, ongoing, held, and missed calls. LED status indications:

- Blinking rapidly when a call is coming in.
- Glowing steadily when dialing, when in a call, and when you have missed a call. To turn the LED off after a missed call, press the right arrow  on the navigation key to view the **Missed calls** menu and simultaneously turn off the LED.
- Blinking slowly when you have put a call on hold.

### Function key LEDs

#### SmartLabel keys P1–P32

Depending on the function mapped onto the key, the red or green LEDs on the key will be activated when the key event occurs. The factory setting is red LED and “line”. The LEDs of a line key will:



- blink rapidly when a call is ringing on the line;
- glow steadily when there is an ongoing call on the line;
- blink slowly when a call is on hold on the line;
- be off when the line is free.

When other functions are mapped onto the keys, the LEDs may glow or blink. For example: When the “extension” function has been mapped onto a key and monitoring of extensions is enabled on both phones, the LED will

- blink rapidly when a call is ringing on the extension;
- glow steadily when the extension is busy;
- be off when the extension is not busy

**MWI key** : Has a red LED that lights up when there is a new message on the mailbox.

**Mute key** : Has a red LED that lights up when and as long as the microphone is muted.

**Speakerphone**  **and headset**  **keys:** Have green LEDs that light up when and as long as speakerphone or headset mode, respectively, are turned on.



## Hard keys







### Context-sensitive, programmable function keys

These function keys can be programmed on the **Function Keys** page of the phone's web interface with a number of key events; these functions will then be available when the phone is in idle mode. For more information, see "Configuring the function keys" on page 52. For the factory default settings, see "At a glance" on page 18.

You cannot change the functions that are available when the phone is active, e.g., when you are in a call, when the phone is ringing, etc. Depending on the activity, different functions will be available.





### Navigation, confirmation, and cancel keys

can be programmed with the key events available in their drop-down menus. See "Configuring the function keys" on page 52 for further information. Factory settings:

Navigation keys	
	<ul style="list-style-type: none"> <li>  <ul style="list-style-type: none"> <li>On idle screen: Press to select identity for outgoing calls</li> </ul> </li> <li>  <ul style="list-style-type: none"> <li>In other contexts: Moving up and down lists one item/button at a time</li> </ul> </li> </ul>
	<ul style="list-style-type: none"> <li>  <ul style="list-style-type: none"> <li>On idle screen, press to scroll left through the favicons.</li> <li>In text fields, press to move the cursor to the left one character at a time.</li> </ul> </li> </ul>
	<ul style="list-style-type: none"> <li>  <ul style="list-style-type: none"> <li>On idle screen, press to scroll right through the favicons.</li> <li>In text fields, press to move the cursor to the right one character at a time.</li> </ul> </li> </ul>
	<ul style="list-style-type: none"> <li>On idle screen: Call features menu.</li> <li>Press to accept calls.</li> <li>Press to confirm actions/settings and return to preceding screen.</li> </ul>
	<ul style="list-style-type: none"> <li>Press to terminate calls.</li> <li>Press to cancel actions and return to preceding screen.</li> </ul>

### Preprogrammed, variably programmable function keys

The factory settings is printed on the key. Other functionalities can be programmed onto them. See "Configuring the function keys" on page 52 for more information.

	Message key. The LED of the key is lit when a new message is waiting on the mailbox. Press the key to retrieve messages.
	Call transfer of active call. See "Transferring calls" on page 46 for further information.
	Redial. Press to show the dialed calls, in descending order with the last one at the top of the list.
	Hold key. See "Hold" on page 45 for further information.

### Audio control keys

	<p>Press the right or left edge of the key to adjust the volume</p> <ul style="list-style-type: none"> <li>of the ringer when the phone is idle or ringing</li> <li>of the loudspeaker in handset, casing, or headset, respectively, when in call</li> </ul>
	Muting and unmuting the microphone
	<ul style="list-style-type: none"> <li>Toggling between handsfree and handset mode</li> <li>Dialing numbers on speakerphone</li> <li>Accepting calls on speakerphone</li> </ul>
	<p>Toggling between headset and handset modes.</p> <p><b>Note:</b> Handset mode overrides headset mode. When the handset is picked up, the headset symbol in the status line will be replaced by the handset symbol, indicating that you can now use only the handset for the call. To return audio to the headset, press  again. The headset symbol will reappear in the status line. You can then place the handset in the cradle without ending the call.</p>

### SmartLabel keys (freely programmable function keys with LEDs)

The freely programmable function keys on the both sides of the display control the SmartLabels (see "SmartLabels" on page 25).

### Alphanumeric Keypad

#### Input modes and navigation

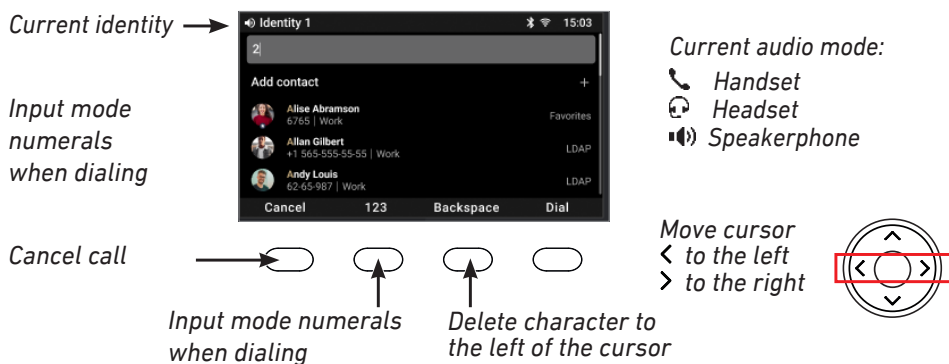

Fig. 1

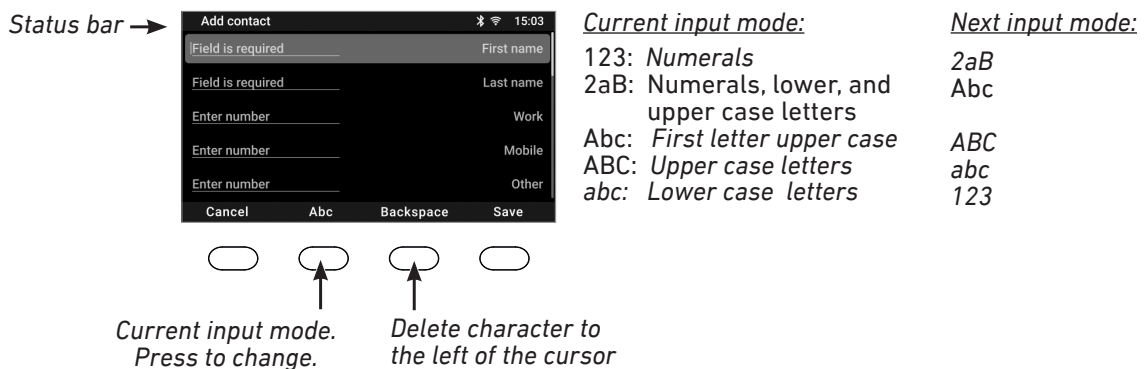

Fig. 2

Press any key on the alphanumeric keypad or pick up the handset to open the dial screen. When dialing a number (Fig. 1), the input mode is always numerals. When editing directory entries and identities (Fig. 2), the current input mode is indicated in the line underneath the cursor. Press the function key underneath the symbol to switch to the next input mode.

Current input mode		Next input mode
123	<b>Press function key to switch to next input mode</b>	2aB
2aB		Abc
Abc		ABC
ABC		abc
abc		123

**Entering numerals, letters, special characters, and symbols**

When entering letters and special characters, pause briefly after each character until the cursor has moved forward so that you won't overwrite the last character you entered. Pausing is not necessary when entering numerals.

**Numerals.** In numeral mode, press the respective number key to type the number printed on the key.

**Letters.** In input modes lower and upper case letters, press the alphanumeric key with the respective letter one, two, three, or four times quickly to type the first, second, third, or fourth letter printed on the key. Pause briefly after each letter.

**Example:** In lower case letter mode, press the "2" key once to type an "a", twice to type a "b", and three times to type a "c".

**Letters with accents and umlauts.** In input modes lower and upper case letters, press the alphanumeric key with the basic form of the respective letter as many times as necessary. Pause briefly after each letter. Available letters with accents and umlauts depend on the phone's language setting.

**Example:** If the phone language is German, press key "2" four times to type "ä".

**Entering special characters and symbols.** In input modes lower and upper case letters, press keys "0" and "1" one or more times quickly. Pause briefly after each character or symbol.

- Period. Press "1" once.
- Space (" "). Press "0" once.
- Underscore ("\_"). Press "0" twice.
- Special characters listed in the following table. Press "1" as many times as indicated:

1x	.	2x	+	3x	@	4x	1	5x	:	6x	,		
7x	?	8x	!	9x	-	10x	_	11x	/	12x	\	13x	(
14x	)	15x	;	16x	&	17x	%	18x	*	19x	#		
20x	<	21x	=	22x	>	23x	\$	24x	[	25x	]		

## Ambient light sensor

The sensor is located in the lower left corner of the glass covering the display and the surrounding area (Fig. 1). The sensor adjusts the backlight in accordance with the ambient light within the sensor's detection area (Fig. 2) when the phone is idle and when it is active.

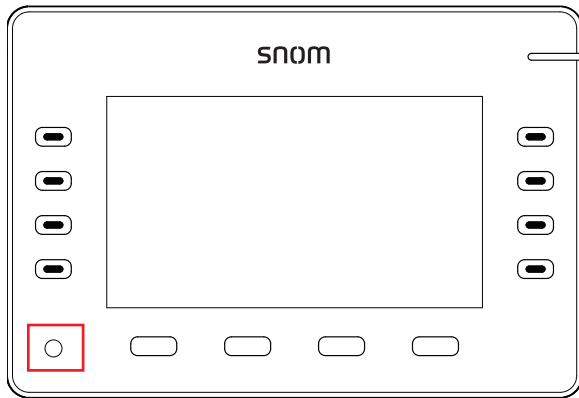

Fig. 1

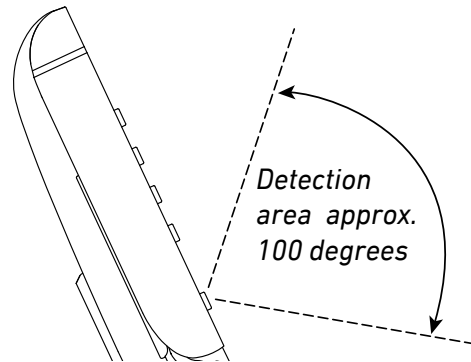

Fig. 2

## Display layout

### In idle mode

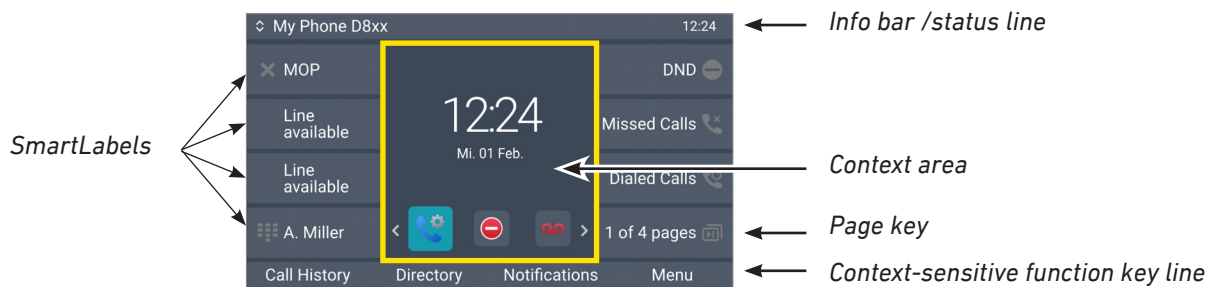

Fig.1, idle screen, SmartLabels in full label mode

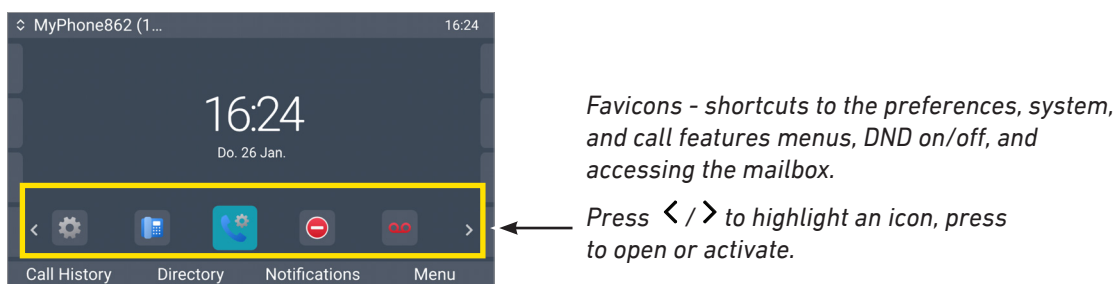







Fig. 2, idle screen, SmartLabels in short label mode

In idle mode, the display presents the following information:

#### Info bar/status line

- Left side: shows the current outgoing identity/account. You can select another configured and active identity by pressing the up and down arrows  $\wedge$   $\vee$  on the navigation key.
- Right side: Time, audio mode, other info (Bluetooth, VPN, etc.) .





**Context area:** Time and date, Favicons.

	Preferences menu		DND on/off
	System menu		Mailbox
	Call features menu		

**SmartLabels**

By default, the labels of the freely programmable function keys are displayed on four (4) "pages" in eight (8) label areas each, four on each side of the display, when the phone is idle; they are hidden when the phone is in a call.

The LED of the key associated with the label will react in accordance with the label's mapping, i.e., the function assigned to the key on a given page; pressing the key may affect what you see on the label.

By default, the lower right key on each page, keys P8, P16, P24, and P32, serves to switch to the next page, from 1 to 2, 3, and 4 and back to 1. The number of the on-screen page, , , , or , is indicated on the page key. The default is ; the display will return to the default after 10 seconds.

**NOTE:** You can assign the **NEXT PAGE** function to another key but one key on each page must have the function if you want to be able to use more than one page.

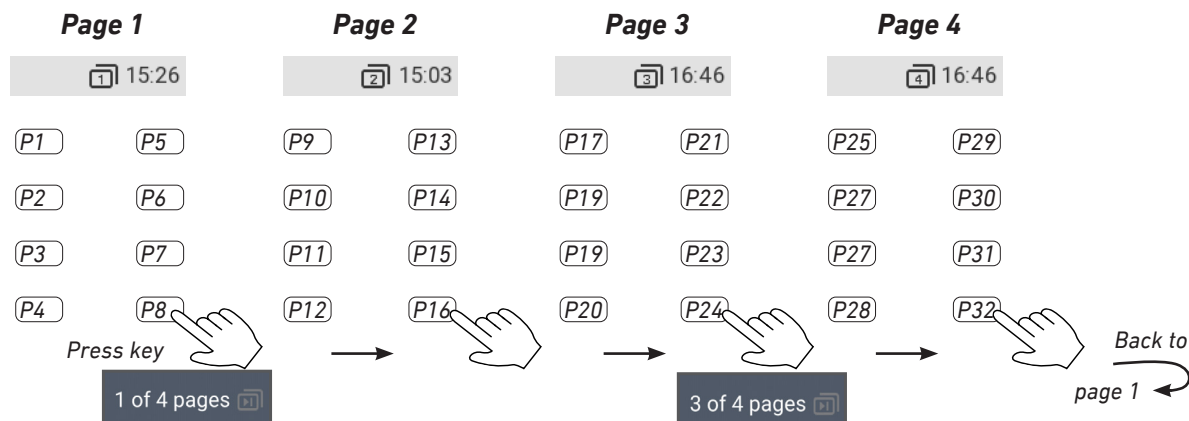

For information on programming the function keys, see "Configuring the function keys" on page 52.

**Function key line**

The text symbols on the buttons in this line name the functions that can be activated by pressing the function key underneath each respective one. See "Appendix 1 - Display Symbols and Icons" on page 75 for a complete list. Factory defaults (may differ, depending on your IP provider or network administration):

Directory	Directory. See "Directory" on page 32.
Call history	Call history (lists of received, dialed, and missed calls). See "Call lists" on page 48.
 Notifications	When <b>Notifications</b> is preceded by the red alert triangle, press the key to display all currently available status messages. Press <b>Dismiss</b> to delete the highlighted message, press <b>Dismiss all</b> to delete all messages. When all messages have been deleted, the triangle and the message in the context area will disappear.
Menu	Main menu

## When the phone is active

The display will inform you of any activity the phone is engaged in. This information is presented in the form of text or symbols or both.

**Info/status bar.** Name of current activity and time.

### Context area

Depending on the activity, this area will contain symbols (incoming call ringing, outgoing call ringing, list entries, etc.) and text like the phone number calling, the extension number being called, conference partners, etc. Depending on the context, the SmartLabels may or may not be shown.

### Function key line

Depending on the current activity of the phone, the key function key line will present various functions that can be activated by pressing the function key underneath the respective symbol. See "Appendix 1 - Display Symbols and Icons" on page 75 for a list of available functions.

## User mode/administrator mode

Snom phones can be operated in administrator or user mode. In administrator mode, all settings are accessible and can be modified; in user mode, a number of settings are not accessible. The factory default is user mode.

For the D8xx series phones, user and administrator mode on the phone and on the web interface are set independently of each other. If the phone is running in user mode, you will still be able to open the phone manager in admin mode if you have the admin name and password.

When the phone is running in user mode, the administrator password is required to switch to administrator mode. If your phone is administered centrally, user mode may be the rule. Please check with your network administrator or IP provider.

When the web interface is opened for the first time upon initialization or after a reboot, you will see the Phone Manager. See "Initialization" on page 15 for further information.

## User names and passwords

We urge you to set an administrator PIN and an HTTP password to protect your phone. There are no default passwords. **Please note:**

- Administrator PIN. If you do not set an administrator password, an unauthorized third party with access to the phone could set an administrator password unknown to you. In such a case, you would no longer be able to switch from user mode to administrator mode to regain access to all phone settings.
- HTTP user name and HTTP password. If you do not set these, you make it easier for experienced hackers to break into your system.

**Note: Be sure to write down your admin password and your HTTP user name and password and store them in a secure place.**

Without the administrator PIN, you will not be able to return the phone and the web interface from user mode to administrator mode; many settings will be inaccessible. Without HTTP user name and password you cannot open the phone's web interface.

You can set and change the data in the phone manager at any time.

1. Press the function key underneath **Menu** on the phone's display and select **Help** to look up the phone's IP address.
2. Enter the IP address into the browser's address bar on a computer in the same network as the phone.
3. If user or admin name and password have been set, enter them and click **Authenticate**; if not, just click **Authenticate**.

### Setting administrator name and PIN

1. Click **Security** in the vertical menu on the left side.

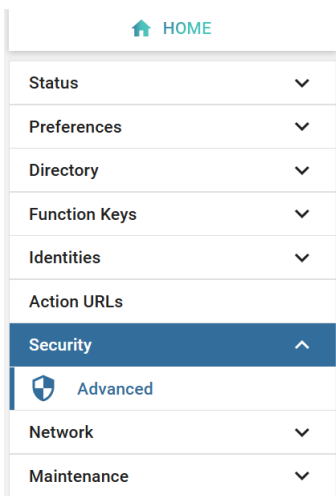

2. Click **Advanced** in the Security submenu.
3. Set **User Name**, **User Password**, **Admin Name**, and **Admin Password** in the respective text fields.

**Note:** The admin fields are not available in user mode, and names and passwords may have been set by your IP provider or network administrator.

Valid values are arbitrary character strings of numerals, letters, and/or special characters of any length. Keep in mind that you may have to enter these characters on the phone's keypad (see "Entering numerals, letters, special characters, and symbols" on page 23). **Write the passwords down and store them in a safe place!**

4. Click **Apply**.

### Setting HTTP user name and password

1. Click **Network** in the left lateral menu.
2. Click **Advanced**.
3. Scroll down to **HTTP Server** and set the **User** name and **Password** in the respective text fields.
  - User name. Valid values are character strings of letters and numerals, e.g. **john** or **jh24**.
  - Password. Text string.
4. Select the **authentication scheme** to be used by clicking **on** or **off** on the toggle switch.
  - Basic scheme: **off**.
  - Digest Authentication Scheme: **on**. This is the more secure option and the default setting.

### Setting user/admin mode on the phone

1. In the **Main menu**, select System.
2. If the phone is running user mode (i.e., administrator access is **off**), press **< / >** to change the setting to **on**. You will be prompted to enter the administrator access PIN. Enter the PIN and press **Confirm**.  
If the phone is running admin mode (i.e., administrator access is **on**), press **< / >** to change the setting to **off**.
3. Press **Back** to return to the main menu.

## Settings

### Phone menu

Settings can be adjusted on the phone and in the Phone Manager, the phone's web interface.

1. On the idle screen, press **MENU** to open the main menu on the display (Fig. 1).

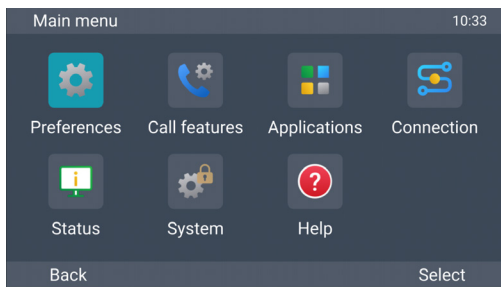

Fig. 1

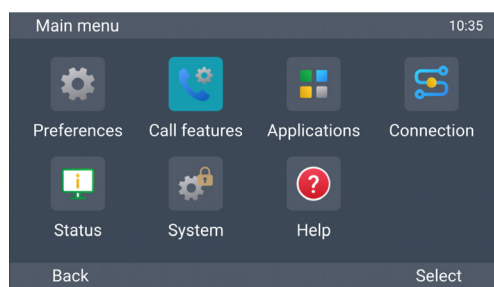



Fig. 2

2. Select a menu with the navigation keys **^ v < >** (Fig. 2).
3. Press **Select** or  to open the highlighted menu.

### Settings available in user mode

Main menu	Submenus or content
Preferences	Language, sound, display, programmable keys
Call features	DND, call forwarding
Applications	Directory, call history (call lists), voicemail
Connection	
Status	System (phone and peripherals HW and SW info), connection (IP, Wi-Fi, Bluetooth)
System	Turn administrator access on, advanced (update settings, reboot)
Help	Shows phone's IP address and URL of Snom Service Hub page for the phone

### Settings available in administrator mode

Main menu	Submenus or content
Preferences	Language, sound, display, programmable keys
Call features	DND, call forward
Applications	Directory, call history (call lists), voicemail



Main menu	Submenus or content
Connection	
Status	System (phone and peripherals HW and SW info), connection (IP settings, Wi-Fi, Bluetooth)
System	Turn administrator access on, advanced (webserver, update settings, reboot, factory reset)
Help	Shows phone's IP address and URL of Snom Service Hub page for the phone

The default mode of the phone is user mode. There is no default admin password to open the phone's web interface unless one has been set by your IP provider or system manager. Most of the individual settings are described elsewhere in this manual.

- **Language:** See "Language settings of phone and web interface" on page 64.
- **Sound.**

- The **volume** of ringer, handset, speaker, and headset can be adjusted while the phone is ringing or in a call by pressing the volume key . It can be also be adjusted in the Phone Manager, **Preferences / Audio**, and in the phone's **Volume** submenu.

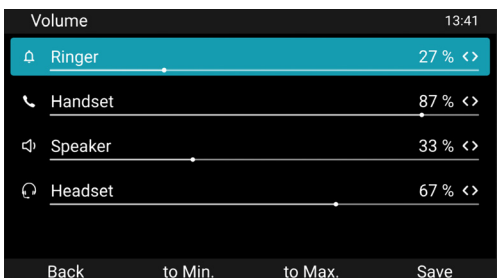

1. Select the device.
  2. Press < or > to decrease or increase the volume.
  3. Press **Save**.
- **Preferred audio.** The default is handset. Select speakerphone or headset with < / > and press **Save**.
  - **Ringer tone.** The phone has 10 built-in tones that can be assigned to individual identities. Press < / > to play the next one, press **Save** to save the selected tone for the current identity.
- **Display.**
    - **Brightness.** The backlight is adjustable between 20% and 100% brightness in steps of 10%.
    - **Screen timeout.** These two setting allows you to dim the brightness of the display after a period of inactivity. The defaults are 50% less brightness after 30 seconds of inactivity. Set wit < / > and **Save**.
  - **Programmable keys.** See "Configuring the function keys" on page 52.
  - **DND.** In DND mode incoming calls do not ring; callers hear the busy signal. Turn "do not disturb" (DND) mode on and off for all identities registered on the phone. If you want to turn on DND for one or more, but not all of the identities (Fig. 2), use the **Identity** settings of the phone manager, **features** section. In DND mode incoming calls do not ring; callers hear the busy signal.
  - **Call forwarding.** See "Call forwarding" on page 50.
  - **Applications.**
    - **Directories.** See "Directories" on page 32.

- **Call history.** See "Call lists" on page 48.
- **Voicemail.** Available if a mailbox has been set up on a server. Please find out the necessary information from your IP provider or network administrator.
- **Status.**
  - **System.**
    - **Phone.** Lists model, hardware and software versions, and MAC address.
    - **Peripherals.** Lists HW and SW info,
- **System.**
  - **Administrator access.**
    - In user mode, press < / > to turn admin access on. A pop-up window appears. Enter the administrator access PIN and press **Confirm**.
    - In administrator mode, press < / > and **Save** to turn admin access off.
  - **Advanced.**
    - In user mode, this menu contains the **Reboot** and the **Update settings** functions. Press **Select** and confirm with **Yes** or cancel the request with **No**.
    - In administrator mode, the menu contains the **Reboot**, the **Update settings**, and the **Factory reset** functions. Press **Select** and confirm with **Yes** or cancel the request with **No**.  
You can also turn the webserver on and off by pressing < / > and **Save**.
- **Help.** This page contains the phone manager's IP address and the URL of the phone's page on Snom's Service Hub.

## The phone's web interface

### How the web interface works

Available items in the vertical menu on the left side of the window depend on whether the phone is running in user or administrator mode.

1. Click a menu item to show the submenus.
2. Click a submenu to open its content in the body.

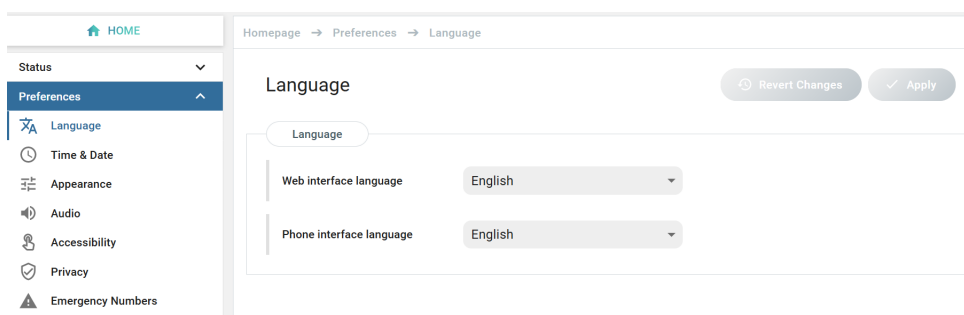

3. If you change a setting, the **Apply** and **Revert Changes** buttons become available. Click **Apply** to save your change(s) before opening another submenu.

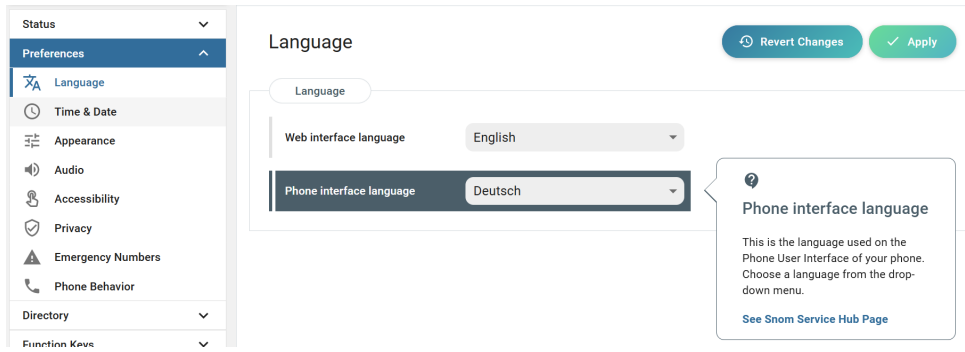

**Note:** Changes will be lost if you open another page or if you close the web interface without first clicking **Apply**.

When you click a setting, a pop-up window with a question mark at the top appears. It contains information on the setting and a link to Snom's Service Hub where you may find more information about it,

### Web settings overriding manual phone settings

In some cases settings activated on the web interface override manual settings on the phone. If a setting you have made on the phone does not appear to take effect, look for a conflicting setting on the web interface or check with your administrator.

# Directories

Currently, the local directory can be edited on the legacy web interface only. It is accessible by adding port 3112 to the phone's URL, e.g. xxx.xxx-xxx-xx:3112.

## Directory

The directory is the built-in directory of the phone. It can hold up to 10,000 entries. Entries can be added and edited on the phone's web interface.

? Directory						
Name:	Number:	Contact Type:	Outgoing Identity:	Edit	Delete	
Jane Smith	9175554128	None	Active			
John Miller						
- fixed	9175554230	None	Active			
- private	9175557018	None	Active			
- cell	9175554231	None	Active			

Any changes you make on the web interface will not take effect until you click on "Save" or on "Apply" and "Save", depending on your firmware version. Changes will be lost if you open another page of the web interface without first clicking on "Apply"/"Save".

## Definitions, explanations

### Directory entries

Each entry must have at least one phone number; multiple associated phone numbers are possible. If you do not enter a first and/or last name and/or nickname, the phone number will appear under both "Name" and "Number".

- Entry with one phone number:

Jane Smith	9175554128	None	Active			
------------	------------	------	--------	--	--	--

- Entry with several associated phone numbers:

John Miller						
- fixed	9175554230	None	Active			
- private	9175557018	VIP	Active			
- cell	9175554231	None	Active			

**Number area (N):** Individual settings for the master record and each subentry possible.

**Blue area.** Data can be different for each associated phone number. If subentry textfields are blank, the data from the master record is displayed.

**Name area.** Same data for the master record and all subentries.

Main record (M)	Subentry 1	Subentry 2
<p>? Add or Edit Entry:</p> <p>Number: 4442090</p> <p>Number Type: <b>N</b> sip</p> <p>Contact Type: VIP</p> <p>Outgoing Identity: Active</p> <p>Group: Work</p> <p>Title: Manager</p> <p>Organization: Smith</p> <p>Email: <b>M</b> jd@smithjones.com</p> <p>Note:</p> <p>Photo:</p> <p>Nick Name:</p> <p>First Name: Jane</p> <p>Family Name: <b>M</b> Doe</p> <p>BirthDay: 14.3.</p> <p>Favorite:</p>	<p>? Add or Edit Entry:</p> <p>Number: 4442091</p> <p>Number Type: <b>N</b> cell</p> <p>Contact Type: VIP</p> <p>Outgoing Identity: Active</p> <p>Group: Work</p> <p>Title: Manager</p> <p>Organization: Smith</p> <p>Email: <b>M</b> jd@smithjones.com</p> <p>Note:</p> <p>Photo:</p> <p>Nick Name:</p> <p>First Name: Jane</p> <p>Family Name: <b>M</b> Doe</p> <p>BirthDay: 14.3.</p> <p>Favorite:</p>	<p>? Add or Edit Entry:</p> <p>Number: 555557815</p> <p>Number Type: <b>N</b> private</p> <p>Contact Type: VIP</p> <p>Outgoing Identity: 555557815@ser.i</p> <p>Group: <b>S</b> Friends</p> <p>Title: <b>M</b> Manager</p> <p>Organization: <b>M</b> Smith</p> <p>Email: <b>S</b> jane.d@madeup.cc</p> <p>Note:</p> <p>Photo:</p> <p>Nick Name:</p> <p>First Name: Jane</p> <p>Family Name: <b>M</b> Doe</p> <p>BirthDay: 14.3.</p> <p>Favorite:</p>

**Blue area of Subentry 2:** Different "Group" selection (**S**), different entry in textfield of "Email" (**S**). No entry in text fields of "Title" and "Organization", therefore they are the same as the master record.

## Contact Types

**VIP:** Calls from numbers with this contact type will ring on your phone even when DND mode is active. You can assign a ringtone to this contact type. If your VIP is also assigned to a group (see below) and if that group has a distinct ringtone, the ringtone assigned to the group will be played.

**Blacklist (Deny List):** Calls from phone numbers with this contact type will not ring on your phone. The caller hears the "Busy" signal. To remove the number from the Deny list, you can either

- delete the entry from the directory by clicking on the "delete" symbol 
- or - if you want to keep the number in the directory - change the contact type to none or VIP by editing the entry. See "Editing existing entry" on page 34 (editing on the phone) and "Editing an entry" on page 35 (editing on the web interface) for more information.

## Outgoing identity

The default setting is "Active" which means that the phone will use the current outgoing identity whenever you dial the number of the phone book entry.

You can also select a specific identity to be used as the outgoing identity whenever the number is dialed, for example, if you want to use a specific VoIP provider for these calls.

**Note:** To use an outgoing identity specified in the directory, you must dial the number from the directory. If you simply type it on the keypad, the current outgoing identity, as indicated on the display, will be used.

## Group

The available group types are **Friends, Family, Work, Colleagues**, or **None**. The default setting is none. You can assign a distinct ringtone to each group type.

## Ringtones

The phone has 10 built-in ringtones that can be assigned to identities, group types, and contact types. It is also possible to download a custom melody.

Assigning ringtones to identities: See "Assigning ringtones" on page 62.

### Assigning ringtones to contact type VIP and group types

1. Open the phone's web interface, **Preferences** page, **Directory Ringtones** section.
2. Select a ringtone from the respective drop-down menu and click on "Apply". If you choose "Custom Melody URL", enter the URL to the data file in the text field. It must be a file of the type PCM 8 kHz 16 bit/sample (linear) mono WAV.

**Note:** Ringers assigned to contact type VIP and to any of the group types override the ringers assigned to the identities. For example, if you have assigned ringer 1 to one of the identities and ringer 2 to the group "Colleagues", the phone will play ringer 2 when a contact from the "Colleagues" group calls that identity.

## Adding/editing entries on the legacy web interface

Click on **Directory** in the menu on the left side.

### Adding new entry

#### 1. Type data in text fields of **Add or Edit Entry**.

- **Number**: Type the number exactly as you would dial it, with country and area codes, if necessary, and without parentheses, hyphens, blank spaces. plenty
- **Number Type**: Select the type of connection from the drop-down menu. The default setting is SIP.
- **Contact Type**: Select "None", "VIP", or "Deny" from the drop-down list. The default setting is "None".
  - Calls from entries on the "VIP" list will always ring on the phone, even when the phone is in a call or in DND mode.

Note: You can assign a distinct ringtone to the contact type "VIP": **Preferences** page > **Audio** tab > **Directory Ringtones** section.

- Calls from entries on the "Deny" list will not ring on the phone. The caller will always hear the busy signal.
- **Outgoing Identity**: The drop-down list shows all identities configured on the phone. If you select one of the identities for one of the numbers listed in the phone book, all calls to that number initiated from the phone book will show that identity on the callee's phone.
- **Blue area**: The data entered in the text fields will be displayed when the entry is opened on the phone. The data can be used to sort entries by group, name, organization, etc., and can be edited on the phone.
  - "Group" drop-down menu: Available types are "Friends", "Family", "Colleagues", or "Work". You can assign a distinct ringtone to each group type: Preferences > Directory Ringtones.
  - "Nickname": If you enter a nickname, it will appear under the "Name" header of the **Directory** on the web interface.
- **First name, family (last) name**: Will be added in this order under "Name" in the directory, unless you have also entered a nickname.
- **Birthday**. Uses the format set at **Preferences** > **Appearance** tab > **General information** > U.S. Date Format (mm/dd): "On" or "Off". Enter in DD.MM.YR or MM/DD/YR format. Examples:

Date	Input	Output when <b>US Date Format</b> setting is	
		On	Off
March 5, 1980	5.3.80 or 3/5/1980	03/05/80	05.03.80
March 12, 1980	12.3.80 or 3/12/1980	03/12/80	12.03.80
October 5, 1980	5.10.80 or 10/5/1980	10/05/80	05.10.80
October 12, 1980	12.10.80 or 10/12/1980	10/12/80	12.10.80

- **Favorite**: Tick box to add entry to "Favorites" list.

#### 2. Click on "Add/Edit" to save new entry to directory.

### Editing an entry

When you open an existing entry, the current information is displayed in the text fields of "Add or Edit Entry" and two additional buttons, "Add Sub" and "Change", are available (see Fig. 2 and 3, below).

- Editing

Name:	Number:	Contact Type:	Outgoing Identity:	Edit Delete
Jane Smith	9175554128	None	Active	
John Miller				
- fixed	9175554230	None	Active	
- private	9175557018	VIP	Active	

Fig. 1

- If single entry, click on in the entry's line.
- If there is more than one number associated with a name:
  - Click on in the name's line if you want to edit/add the first or last name of the date of birth and the data in the blue area applicable to the master record.
  - Click on in a phone number's line if you want to edit the subentry's data (phone number, number & contact type, outgoing identity, and any blue area data applicable to this subentry only).

Make changes as necessary and click on "Change".

- Adding additional phone number (subentry) for a name
  - Jane Smith's entry has only one phone number, her SIP phone number. In this example, the phone number of Jane Smith's landline will be added to the directory.
    - Click on in Jane Smith's line (Fig. 1, above). The data is shown in "Add or Edit" area (Fig. 2).

Fig. 2

Fig. 3

- Enter the phone number in the text field of "Number" (Fig. 3).
- Select "fixed" from the drop-down menu of "Number type" (Fig. 3).
- Optional: Select a contact type and an outgoing identity from drop-down lists (Fig. 3).
- Click on "Add Sub" (Fig. 3).
- John Miller's entry has a SIP number and a private number. In this example, his cell phone number will be added as a third number.

- Click on  in the line containing John Miller's name. The data is shown in "Add or Edit" area.
- Enter the phone number in the text field of "Number".
- Select the number type.
- Optional: Select a contact type and an outgoing identity from the respective drop-down list.
- Click on "Add Sub".

The directory now contains Jane Smith's landline number and John Miller's mobile phone number (Fig. 4).

















Name:	Number:	Contact Type:	Outgoing Identity:	Edit	Delete
Jane Smith					
- sip	9175554128	None	Active		
- fixed	9175554129	None	Active		
John Miller					
- fixed	9175554230	None	Active		
- private	9175557018	VIP	Active		
- cell	9175554231	None	Active		

Fig. 4

### Deleting entry on web interface

- Entry with one phone number. Click on  in the entry's lines to delete the entry.
- Entry with more than one phone number.
  - Deleting the entry. Click on  in the line of the master record to delete the name and all associated phone numbers.
  - Deleting one of the phone numbers. Click on  in the line of a phone number subentry to delete that subentry, but keeping the master record and all other subentries.

### Dialing from phone directory

To dial, click on the phone symbol  on the right side of the line with the phone number.

### Deleting whole directory

Deletes the entire directory irretrievably!

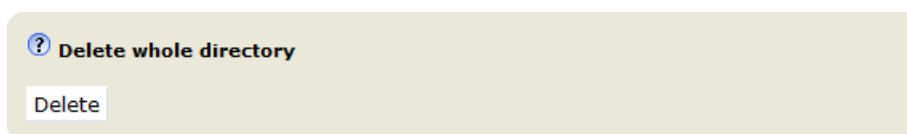

### Importing/exporting a directory

See our Service Hub at <https://service.snom.com/display/wiki/Phone+directories>.



## External directories

Available if provided by your network, your VoIP provider, or another external source.

### LDAP

1. In the Phone Manager, click Directory in the left lateral menu.
2. Click LDAP.
3. Enter the necessary data received from your administrator, VoIP provider or other external source in the text fields.
4. Click **Apply**.

LDAP search on the phone: Enter the first letter of the name you are searching for. Type more letters if the name shown isn't the right one or scroll through the list. Press **Dial** to dial.

### Contacts

If you want to use an external contacts list, the **Contact list** and **Contact list URI** settings are mandatory. **Publish presence** is optional; when enabled, the phone sends out "PUBLISH" SIP messages with the phone's status, e.g. busy, etc.

1. On the phone's web interface, **Configuration Identity #** page, **SIP** tab, click on the radio button **on** of the **Contact list** entry.
2. Enter the URI received from your administrator, VoIP provider or other external source in the text field of **Contact list URI**.
3. Optional: Click on the radio button **on** of the **Publish presence** setting.
4. Click on **Apply** and **Save**.

The screenshot shows the 'SIP Identity Settings' page with the following settings:

- Voice Quality Report Collector: [Text Field]
- Music on hold server: [Text Field]
- Send hold as inactive:  on  off
- Alert Info URL: [Text Field]
- User picture URL: [Text Field]
- Dial-Plan String: [Text Field]
- Count all groups in Dial-Plan:  on  off
- ENUM Support:  on  off
- Countrycode: [Text Field]
- Areacode: [Text Field]
- Proxy Require: [Text Field]
- Additional supported headers: [Text Field]
- Q-Value: 1.0
- Proposed Expiry: 120
- Auto Answer:  on  off
- Long SIP-Contact (RFC3840):  on  off
- Support broken Registrar:  on  off
- Shared Line:  on  off
- Publish Presence on bootup:  on  off
- DTMF via SIP INFO: off
- Send display name on INVITE:  on  off
- Extension Monitoring Call Pickup List URI: [Text Field]
- Contact List:  on  off
- Publish Presence:  on  off
- Contact List URI: [Text Field]

To dial a contact on the phone, enter the first letter of the name you are searching for. Type more letters if the name shown isn't the right one, or scroll through the list. Press **Dial** to dial.

## Using the phone

This section describes the functions of the phone with the factory default settings. If your phone was installed and/or set up by someone else, the default settings may have been changed. Please check with that person or company if the phone does not react as described here.

The caller information displayed on the screen is controlled by a setting on the phone's web interface. The default setting is "Name + Number". To change the setting, click **Preferences** in the left lateral menu, then **Appearance**. In the **Interface elements** section, select an option from the pull-down menu **Number Display Style**. The other options are Full contact, name, number, and number + name.

## Making calls

See "Entering numerals, letters, special characters, and symbols" on page 23 for information on input modes and entering letters, numerals, and special characters.

## Selecting identity for current outgoing call

See "Identities/accounts" on page 60 on how to configure identities.

◇ My Phone D8xx 12:24

Your current outgoing identity is shown on the left side of the status line. To select another configured identity, press  $\wedge$  /  $\vee$  on the navigation key.

## Using different audio devices

### Handset

- Pick up the handset, enter the phone number, and press  OR
- enter the phone number and pick up the handset.

### Headset

Enter the phone number and press .

### Speakerphone



Enter the phone number and press **Dial** or .

## Using different dialing methods



### Auto dial

When this function is enabled, the phone will dial the number on the display when the time span in seconds specified in this setting has elapsed since the last digit was typed. In the default setting, the function is switched off. It can be enabled on the web interface. For the settings, see "Auto dial" on page 69.

## Redialing

1. Press  to show the last numbers dialed (i.e., the call history for dialed calls), with the very last number at the top.
2. Press **Dial** or  to dial that number or use  $\wedge / \vee$  to select a different number and then press **Dial** or .

## Calling number from call history (missed, received, dialed calls)

In the default setting, the list of dialed calls can be accessed directly by pressing the redial key  and the left and right arrow "key" on the navigation key , respectively. The call history is also available in the **Applications** menu on the idle screen. For further information, see "Call lists" on page 48.

1. Press **Call history** on the idle screen to open the call history menu and select a call list in the call history menu.
2. Press  $\triangleright$  to enter the call list.
3. Use  $\wedge / \vee$  on the navigation key to select a call on the list.
4. Press **Dial** or  to dial the selected number.

## Calling number from a directory

1. Press **Directory**.
2. Press **Search** to search all directories.
  - Alternatively, select a directory with  $\wedge / \vee$ , then press **Search**.
  - Alternatively, press  $\triangleright$  to enter the highlighted directory, then press  $\wedge / \vee$  on the navigation key to scroll to an entry.
  - Press **Cancel** to return to the **Directory** menu.
3. If you want to be able to search for names und numerals, select input mode **2ab**.

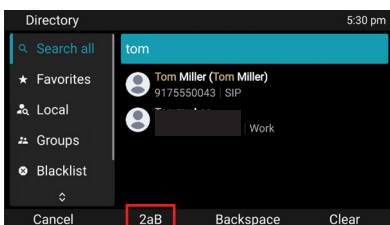

4. Enter the first letter(s) of the name or first digits of the number.
5. Press **Details** if you want to view the entry before dialing.
6. Press **Edit dial** if you want to edit the number before dialing.
7. Press **Dial** or  to dial the number.

## Speed dialing

There are two different types of speed dialing numbers on Snom phones:

- Phone numbers given shortcuts to be typed on the alphanumeric keypad. dialed by long-pressing the speed dial numbers 0–9 on the alphanumeric keypad.
  1. Long-press the speed dial number (0–9) assigned to the phone number you wish to dial.
  2. Press **Dial** or  to dial.
- Speed dial number assigned to a SmartLabel key: Press the key to dial.

Setting speed dial numbers: See "Speed dial" on page 68. Mapping a speed dial number onto one of the freely programmable function keys: See "Configuring the function keys", "Example 2, Speed dialing" on page 58.

## Calling emergency numbers

Numbers specified as emergency numbers can be dialled even when the keyboard is locked. See "Emergency numbers" on page 65 on how to set emergency numbers. Several numbers (911, 112, 110, 999) have been preconfigured.

- On an unlocked keyboard: Enter the number and press **Dial** or  to dial.
- On a locked keyboard: Enter the number. The phone dials the number as soon as you have entered all the digits of one of the programmed emergency numbers.

## Call completion

**Note:** This function depends on whether it is available in your network or not. On Snom phones call completion means that when a called number is busy or not available, you can have your phone call you back as soon as the dialed number is not busy anymore or available again. The default setting is "off".

Changing the setting to turn on call completion : See "Call completion" on page 67.

1. When call completion is available and enabled and a number you dialed is busy, the display shows this prompt:

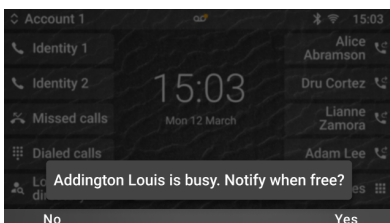

2. Press **Yes** if you want your phone to ring you back when the number is no longer busy; press **No** if you do not want call completion for this call.
3. You can now hang up the handset to return to the idle screen; use handset, headset, or speakerphone to dial another number; receive calls etc. Call completion will not interfere with the normal operation of your phone.
4. When the number becomes available, you will see it announced on the display:

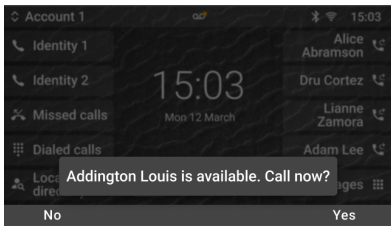



5. Press **Yes** if you want the phone to redial the number; press **No** to terminate call completion for this call.

**QuickLookup (number guessing/auto completion)**

As soon as you have entered the first character, the phone begins searching its directories and call lists - and send an LDAP query if LDAP is configured - for names and numbers matching the sequence typed on the phone's keypad.

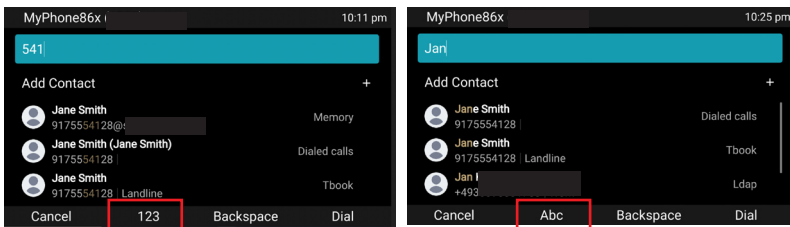
1. Start entering the name of the person or the phone number or any part of the phone number you want to call.



2. The matching results are shown on the display.
3. If the number of matches, as indicated on the right side of the edit line, exceeds the number that can be shown on the display, use the ^ / v arrows on the navigation key to scroll through the list.
4. Select the number you want to dial and press **Dial** or  to dial.

## Accepting calls

### Using different audio devices

**Handset:** Pick up the handset.

**Headset:** Press .

**Speakerphone:** Press **Answer** or  or .

### Automatically accepting calls

The default is **off**. Turning the function on for an identity (admin mode only): on the phone's web interface click **Identities**, select the identity, and click **SIP**. Scroll down to **Auto answer** and click **on** on the on/off toggle switch. With this setting, your phone will automatically accept incoming calls when it is idle.

Calls will be accepted on speakerphone, and you will be alerted acoustically by a single long beep. Press the headset key  if you want calls to go to the headset.

To turn off the acoustic alert, click **Preferences**, then **Audio**. Scroll down to the **Auto Answer** section and click the on/off toggle of **Auto Answer Indication** to **off**.

### Call pick-up from another extension

You can pick up calls ringing on another extension, for example when the other extension is busy or when the user is absent, by pressing a SmartLabel key on your phone (see "SmartLabels" on page 25). The prerequisites for this function are as follows:

- It must be supported by the PBX.
- The extensions whose calls you want to pick up on your own extension must permit this function. It is possible but not required to restrict the permission for monitoring to certain users or groups of users.

Settings: See "Example 1, Extension monitoring and call pick-up" on page 57.

- Each extension to be monitored must be programmed onto one of the SmartLabel keys with LEDs on the phone or onto a function key on a connected expansion module. See chapter "Configuring the function keys", "Example 1, Extension monitoring and call pick-up" on page 57.
- If you want to see who is connected to or calling any of your monitored extensions, the function must be enabled; the default setting is off. It can be turned on in admin mode only. Open the phone's web interface click **Preferences**, then **Phone behavior**. Scroll down to **Go to call-monitor on activity** and click the on/off toggle to turn the feature **on**.

When these prerequisites are met, the status of the monitored extension is indicated by the LED of the function key:

- Blinking LED: Incoming call ringing. If the call is not answered, press the key or **Answer** to pick it up;
- LED glowing steadily: The monitored extension is busy (in call, dialing, etc.);

and by the idle display showing the call-monitor state. The first extension is the caller, the second one the callee.

- Call ringing. "7788 > 7904" indicates that extension 7788 is calling extension 7904.
- In call. "7781 x 7793" indicates that 7781 is connected to 7793 and that 7781 is the caller. 7793 the callee.

Press  to close the **Calls** screen and return to the idle screen.

## Call waiting

When you are in a call, another call coming in will be announced visually by the flashing call LED and by the announcement of an incoming call on the display, and acoustically by a double beep. If the caller ID is transmitted, it will also be shown on the display.

Call waiting can be restricted to visual or acoustic announcement only or turned off altogether. See "Call waiting" on page 67 for the instructions on how to change the setting.

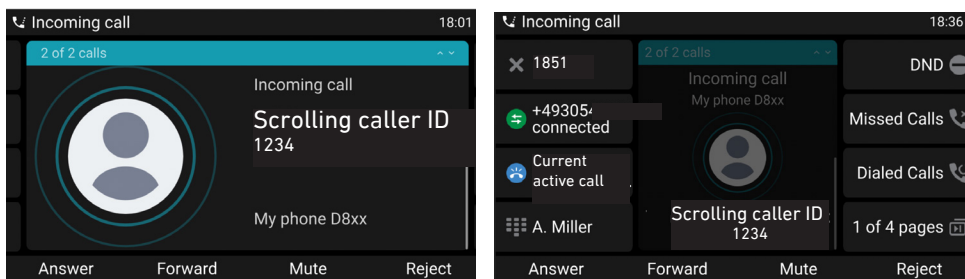

*Call screen, default mode short label*

*Call screen, alternative mode full label*

When a call is waiting, you have the following options:

- Accept the call waiting and put the current call on hold. You can accept the call waiting by
  - pressing the blinking line key of the incoming call. This option is available only when there is a free line key available at the time the call comes in.
  - pressing the function key underneath **Answer**.
- Reject the waiting call. Press **Reject**. The caller will hear the busy signal.



## Active calls

### Hold

#### One call on hold

Press Hold or  to put the ongoing call on hold. Held calls are indicated as follows:

- By the text on the display.
- By the slowly blinking line key.
- By the slowly blinking call indication LED.
- By the double beep when you put a call on hold..

You can now:

- transfer the held call blindly or with prior announcement - see "Transferring calls" on page 46.
- receive and make calls and put other calls on hold.

Pick up the held call by pressing its line key or by pressing  again. If the other party hangs up while on hold, the call is terminated on your phone as well, and the LED indicators are turned off.

#### Holding multiple calls

The status lines at the top of the display indicate the number of calls on your phone.



*Two calls, one active, one on hold.*

*Two calls, both on hold.*

Press  $\wedge$  /  $\vee$  to scroll through the calls. Your input on the phone's keys will affect the call on the display. It can be resumed, terminated, or selected for conference setup.

## Conference

The maximum number of participants in phone-based conferences is three.

**Note:** This section refers to phone-based conferences. For the number of participants in server-based conferences and how to set up and join them, please check with your network administrator or your VoIP provider.

#### Initiating a conference

1. With a call on the line, press **Conference**. The call is put on hold.
2. Dial the number and announce the conference

3. Press **Join**.
4. Press **End call** to terminate the conference.

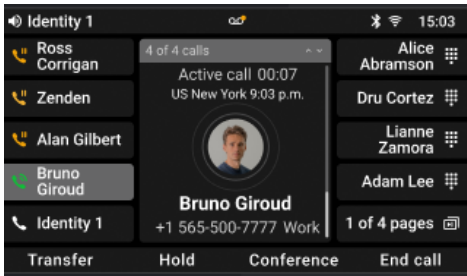

- If you have a SmartLabel key set up to speed dial a number, you can blindly add that party to the conference.
  1. With a call on the line, press **Conference**. The call is put on hold.
  2. Press **Blind conf**.
  3. Press the SmartLabel key to start the conference.
- Put conference on hold. Press **Hold**. Press **Resume** to restart conference.
- Press **Details** to open the interactive screen. Use  $\wedge$  /  $\vee$  on the navigation key to select individual participants or the conference. Your input on the phone's keys will affect the highlighted participant or the entire conference.
  - You can mute or remove the highlighted individual participant.
  - You can end or split the highlighted conference.
- Call waiting while in a conference.
  - Press **Reject** (possible only if maximum number of participants is not exceeded):
  - Press **Answer**. The conference will be put on hold. Press **Add** to add the caller to the conference.

## Transferring calls

You can transfer connected calls as well as calls ringing on your phone.

- When you have a call on the line, there are two ways to transfer it to a third party:
  - Announcing the call to the third party first, to make sure the call is welcome and will be accepted: attended transfer.
  - Transferring the call unannounced: blind transfer. There will be no feedback on whether the third party is available and/or picking up the call.
- When a call is ringing on your phone, you can transfer it to a third party without answering it first (blind transfer only).

### Attended transfer

- With a single call on the phone.
  1. Press **Transfer**.
  2. On the **Xfer setup** screen, enter the number manually or select a number from the phone's call lists.

3. Press **Dial**, putting the active call on hold.
  4. If the third party agrees to accept the call, press **Transfer**. The call is transferred.
  5. If the third does not want to take the call, press **Cancel**, then **Resume** to resume the held call.
- With more than one call. The active call will be transferred. If the active call is not the one you want to transfer, put it on hold, select the other call with **^ / v** and press **Transfer**.
    1. On the **Xfer setup** screen, enter the number or select a call from the phone's call list.
    2. Press **Dial**.
    3. If the third party agrees to accept the call, press **Transfer**. The call is transferred.
    4. The remaining call on hold or the first of the remaining calls on hold will then appear on-screen.

### Blind transfer

- **Blind transfer of active call**

1. With a call on the line, press **Transfer**. The **Xfer setup** screen appears.
2. Press **Blind xfer**.
3. Enter the number or select a call from the phone's call list.
4. Press **Blind xfer**. The display shows the message **Call ended** while the call is ringing on the third party's phone.

- **Blind transfer of call waiting**



1. If you are in a call and want to transfer a call waiting, press **Forward** with the incoming call on the display.
2. On the **Forward call** screen, enter the number or select a call from the phone's call list.
3. Press **Forward**. The display shows the message **Call terminated** while the call is ringing on the third party's phone.

**Note: Your active call remains active while you are transferring the ringing call.**

- **Blind transfer of ringing call**

1. With a call ringing, press **Forward**.
2. On the **Forward call** screen, enter the number manually or select a number from the phone's call list.
3. Press **Forward**. The display shows the message **Call terminated** while the call is ringing on the third party's phone.

## Terminating calls

- When using the handset: place the handset in the cradle or press **End call** or .
- When using speakerphone or a headset: press **End call** or .

## Missed calls

Missed calls are indicated by the call LED (steady light), the missed call message with the number of new missed calls in the contact area, and by the symbol appended to **Notifications** if the functionality has been assigned to one of the function keys.

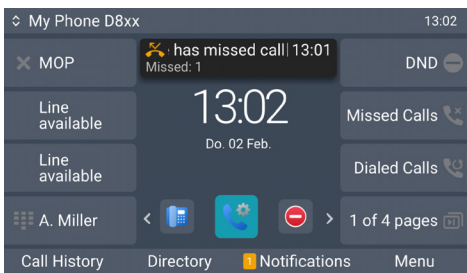

- Viewing your missed calls.
  1. Press **Menu**.
  2. Select **Applications**.
  3. Select **Call history** and press **>** on the navigation key.
  4. Select **Missed** with **∨** and enter the list with **>** or .
  5. Scroll with **∧** / **∨**.
- Turning off the missed call indications (LED and message). Use one of the following methods:
  - View the missed call list.
  - View **Notifications** and press **Dismiss** to delete the call. It will still be shown on the missed calls list.

## Call lists

Four call lists of missed, dialed, received, and all calls are stored on the phone. They contain the number, name (if available), and the time (if the same day) or date of the calls. If the memory allotted to storing the call lists is full, the oldest ones will be overwritten. You can view all calls in the list of all calls, sorted by date and time.

1. Press **Menu**.
2. Select **Applications**.
3. Select **Call history**.
4. Select a list with **∧** / **∨** and enter the list with **>** or .
5. Select a call with **∧** / **∨**.
  - You can **dial** or **delete** the call or
  - press **More** and then **Edit dial** to edit the number before dialing or add it to your local contacts.

## Locking and unlocking the keyboard



TBA

## Rejecting or redirecting incoming calls

This includes manual and automatic rejection and redirection and automatic rejection of anonymous calls.

### Manually

If you do not want to pick up a ringing call, you have three options: Letting the call ring and not picking it up, rejecting it manually, or transferring it manually to a third party.

- Rejecting a ringing call manually.
  - Press **Reject** or . The caller will hear the busy signal.
  - Press  for two seconds to reject the call and additionally place the caller on the "Deny" list of the phone's directory so that calls from that number will never ring on your phone; the caller will always hear the busy signal. For more information on the "Deny" list and how to edit or remove entries from it, see "Contact Types" on page 33.
- Transferring the ringing call to another phone (blind transfer). See "Blind transfer of ringing call" on page 47.

### Automatically

There are four options for rejecting incoming calls automatically or to have them forwarded automatically, either always or under certain conditions:

- Blacklist (Deny List). Calls from phone numbers on this list will not ring on your phone; callers will hear the busy signal. For further information, see "Contact Types" on page 33.
- DND - do not disturb mode . When this function is turned on, callers hear the busy signal. If there is an active setting for call forwarding on busy, incoming calls will be forwarded to the number specified in the setting.

**Exception:** Phone numbers designated VIP in your phone's directory will ring on your phone even when DND is on.

- Call forwarding. For further information, see "Call forwarding" on page 50 and 66.
- Rejecting anonymous calls: See next section.

## Rejecting anonymous calls

With this setting you can have your phone reject calls from phones that are blocking or not transmitting their numbers.

**Please note:** Calls from analog phone connections without caller ID will, most likely, be received as anonymous calls. They will be rejected when you turn this function on.

### Activating/deactivating rejection of anonymous calls

1. Click **Preferences** in the left lateral menu of the Phone Manager.
2. Click **Privacy**.
3. Click reject or accept on the toggle switch of **Reject incoming anonymous calls**.
4. Click **Apply** to save.

## Call forwarding

The phone can be set to forward incoming calls, either always or when the phone is busy or an incoming call has not been answered within a specified amount of time. The settings can be done on the phone and on the web interface.

**Note:** Call forwarding is set separately for each configured identity. When the setting is done on the phone, it applies to the identity selected as outgoing identity. To turn on call forwarding for several configured identities, select each one in turn as the outgoing identity and repeat the setting.

For information on using the web interface for these settings, see "Call forwarding" on page 66.

**Forward All.** Forwarding all incoming calls to the number of the phone, extension, or mailbox specified as this function's target.



**Forward when Busy.** Forwarding calls ringing while the phone is busy to the number of the phone, extension, or mailbox specified as this function's target.

**Forward after Timeout.** When a call starts ringing, the phone will wait for the number of seconds specified in the setting "Call forwarding time". If the call has not been accepted by the end of this time period, it is forwarded to the number of the phone, extension, or mailbox specified as this function's target.



## Settings on the phone

1. Press **Menu**.
2. Select **Call features**.
3. Select **Call forward**.
4. Select your identity/account.
5. Select the call forwarding method (always, busy, or no answer) you want to set.

6. Press  to change the current setting from **off** to **on**.
7. Repeat steps 5 and 6 for each call forwarding method you want to set.
8. Press **Back** to return to the previous screen.
9. To turn call forwarding off, follow steps 1 to 5 and press  to change the setting to **off**. Repeat for each call forwarding method you want to turn off, and press **Back** to return to the previous screen.

## Configuring the function keys

See "The phone's web interface" on page 30 on how to open the phone's web interface and on navigating in the windows and changing the settings.

Any changes you make will not take effect until you press **Apply**. Changes will be lost if you open another page of the web interface without first pressing **Apply**.

### Function key types on Snom phones

Every phone has a limited number of hard keys. Phone users, however, have a myriad of different priorities and preferences when asked which functions they use most often and which functionalities they would like to access quickly. Snom has therefore designed the function keys to be programmable, even the preprogrammed "hard keys" whose default function is printed on them.

There are four types of programmable function keys (see also "At a glance" on page 18):

- **Context-sensitive, programmable function keys.** For the default settings, see "At a glance" on page 18. You can select a different key event as well as other functions like call forwarding or intercom to be available on each respective key when the phone is in idle mode. See "Example 3, Changing setting of context-sensitive key" on page 59 for step-by-step instructions on how to change the function mapped onto the key.

You cannot change the functions that are available when the phone is active, for example when you are in a call, when the phone is ringing, etc. Depending on the activity, different functions will be available.

See "Appendix 1 - Display Symbols and Icons" on page 75 for the lists of symbols and their description.

- **Navigation, confirmation, and cancel keys.** For the default settings, see "At a glance" on page 18. You can select a different key event to be available on each respective key when the phone is in idle mode.

You cannot change the functions that are available when the phone is active, for example when you are in a call, when the phone is ringing, etc.

- **Dedicated, customizable function keys.** The default setting is the respective key event printed onto the hard key. Other key events and a selected number of other functionalities can be programmed onto them. For the default settings, see "At a glance" on page 18.
- **Freely programmable function keys with LEDs** – the keys controlling the SmartLabels – on the phone and on connected expansion modules. All available functionalities, including key events, can be programmed onto them.

When an expansion module is connected to the phone, its function keys are added to the settings menu of the phone and to the **Function Keys** page of the web user interface of the phone.

**Note:** For information on connecting the expansion module, please refer to the user manual on Snom's Service Hub at <https://service.snom.com>. The user manual also contains specific information on the device's configuration.

The settings of the function keys on the expansion modules are stored on the phone and, unless deleted prior to the module's disconnection, remain available to be used when the same or any other module of the same type is connected to the phone. They are not visible on the function



keys page when no expansion module is connected.

### Settings descriptions:

- **Context**

This setting specifies which configured identity will be used when executing the functionality of the key. You may want to use this feature when you have accounts with different providers or when you wish to present different identities to certain destinations.

For example: If you have programmed key P2 to speed dial a specific number and you want to use configured identity 2 to call that number, select configured identity 2 from the drop-down menu of P2's "Context". When you speed dial the number by pressing key P2, identity 2 will be used as the outgoing identity.

The default setting is "Active", which means that the identity selected as the phone's outgoing identity at any given time will be used.

- **Type**



Select the type of functionality from the drop-down list. If you select "Key Event", a drop-down list with the available key events will replace the text field under "Number". The default setting is "line".

- **Number**

Enter one phone number or value for the function or, if the function is key event, select an event from the drop-down list. Enter phone numbers exactly the way they need to be dialed, i.e, type the number without spaces or punctuation marks between the digits. For example, a number with an area code that might conventionally be notated as (617) 555-0704 should be entered as 6175550704.

- **Short/Full Label Mode (phone)**

Select a mode from the list (see Fig. 3 and 4 on page 26). The default settings for both are icon and text.

- **Icon.** The label will display the icon of the functionality mapped onto the key, e.g., , if extension; , if speed dial; etc.
- **Text.** The label will display the text you have entered in the full label text field or the number, if no text was entered.
- **Icon and text.** The label will display the icon of the functionality mapped onto the key and the text or number.

- **Short/Full Label (phone), Label (expansion module)**

Optional: Enter a name or other descriptive text in the text field. This is the data displayed on the key's label area on the phone and on the expansion module's display, respectively. If you leave the field blank, the number will be displayed in the key label area.

## Display options for SmartLabel keys

There are two display modes for the SmartLabels on the display, full and short label mode.



Full label mode



Short label mode

Briefly pressing any of the SmartLabel keys when the default setting for idle screen or the call screens is short label mode will turn on full label mode for the number of seconds specified in **Reset to default display mode after (sec.)**.

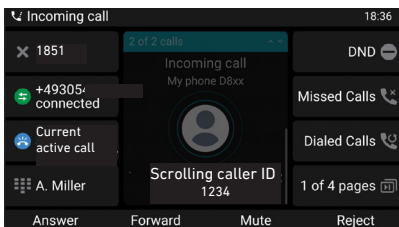

Full label mode on call screen

### Settings on the web interface

1. In the Phone Manager, click **Preferences** in the left lateral menu.
2. Click **Accessibility**.
3. Scroll to the screen settings.
  - **Idle screen.** Select full, short, or off for the default and the alternative display mode from the drop-down menu. The defaults are full label for the default and the alternative display mode.
  - **Call screens.** Select short or off for the default and full or short for the alternative display mode from the drop-down menu. The defaults are short label for the default display mode, full label for the alternative display mode.
4. Scroll to **Options**.
  - Setting **Reset to default display mode after (sec.)**. This setting defines after how many seconds the SmartLabel will return from full to short label mode. The default is three (3) seconds, valid values are 1 to 360 seconds. If set to zero (0), reset will be disabled, and the last viewed label page will remain on-screen.
  - Setting **Return to label page 1 after (s)**. This setting defines after how many seconds the page key will revert to page 1. If the setting is empty, the page key will not revert to page 1.
5. Click **Apply** to save your settings.

## Programming the function keys

The context-sensitive keys (softkeys) underneath the display can be mapped on the phone and on the phone's web interface, the other function keys on the phone's web interface .

### Context-sensitive keys

#### Setting on the phone

1. In the Preferences menu, select **Programmable keys**, then **Softkeys**.
2. Select the key.
3. Select the key type with **< / >**. Alternatively, press **Show list** and select a key type with **Page down** and **Page up**.

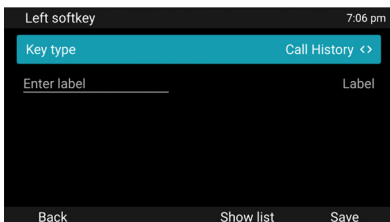

4. Unless you enter a different label text, the label on the display will use the name of the key type.
5. Press **Save**.

#### Setting on the web interface

1. In the left lateral menu of the Phone Manager, click **Function keys**.
2. Click **Context-sensitive keys**.
3. Select the left (F1), middle left (F2), middle right (F3), or right key (F4).
4. Select a **type**. The default is key event.
5. Select a function from the drop-down menu of the adjacent text field.
6. Click **Apply**.

### SmartLabel keys (PFK)

Functions and values for the function keys on the phone and any connected expansion modules are assigned on the **Function key** page of the web interface. When the SmartLabels are not shown, the LED keys will still react and can be used in accordance with the functions mapped onto them.

- See "Selected examples for function key programming" on page 56 for the instructions on assigning functions.
- See "Display options for SmartLabel keys" on page 56 for the configuration of the optical presentation of the labels on the display.

When **Expansion Modules** are connected to the phone, their function keys are added to the function key page of the phone. The settings of their function keys are stored on the phone and, unless deleted prior to the module's disconnection, remain available to be used when the same or any other module of the same type is connected to the phone.

The keys on the second and third module can be used only when a second and third module, respectively, are connected to the phone. Expansion module keys are not shown in the phone menu or on the function keys page when no expansion module is connected.

### Configuring the functions on the Phone Manager web interface

1. Click **Function Keys** in the left lateral menu.
2. Click **SmartLabel keys (Line keys)**.
3. At the bottom of the main window is the page indicator.



4. Depending on the number of lateral keys available on your phone type you'll find numbered keys on each page. For example, if your phone has four SmartLabel keys on either side of the display, the page contains keys P1 through P8.

*P4 is situated on the left side of the display, P5 on the right. See the diagram at "SmartLabels" on page 25.*

5. Select a key.
6. If you make any modifications to the settings, click **Apply** to save them before opening the other subpage or any other page of the phone's web interface, and before closing the web interface.

### Selected examples for function key programming

This chapter will show you a few examples for customizing function key settings to your needs and preferences, using the phone's web interface:

- First example: Extension monitoring and call pickup via one of the phone's freely programmable and self-labeling function keys with LED
- Second example: Speed dialing with a freely programmable function key with LED
- Third example: Changing setting of context-sensitive key

### Example 1, Extension monitoring and call pick-up

This feature makes it possible to pick up a call ringing on another extension registered at the same registrar, for example when the other extension is busy or when the user is absent. The SmartLabel and the key's LED will also signal when the extension is busy and allow you to dial the number with one key press when it is not.

The prerequisites for this function are:

- It must be supported by the PBX.
- The extensions must permit this function. Setting: Phone's web interface > **Identity** > click an identity > click **SIP** > setting **Allow incoming extension monitoring**. The default is **on**.
- Restricting permission to groups of users by setting an ID: Phone's web interface > **Identity** > click an identity > click **SIP** > setting **Extension monitoring group ID**: enter an ID (any character string) into the text field. Note: The first character of the ID must not be a '{' curly brace.
- The extension to be monitored must be programmed onto one of the freely programmable function keys with LEDs.

1. On the phone's web interface, click **Function Keys** in the left lateral menu.
2. Click **SmartLabel keys** (Line keys).
3. Select a page, if necessary.
4. Select a key.
5. Under **Context**, select "Active" or one of the configured identities from the drop-down list.
6. Under **Type**, select "Extension" from the drop-down list.
7. In the **Number** text field, enter the extension number that you want to monitor.
8. Select a display option from the drop-down menu of **Short Label Mode**. The default is "Icon and text", i.e., an icon depicting the function on the key and the number or the short label text will be displayed on the display. name or descriptive text.
9. Select a display option from the drop-down menu of **Full Label Mode**. The default is "Icon and text", i.e., an icon depicting the function on the key and the number or the short label text will be displayed on the display.
10. Optional: In the text fields of **Full Label** and **Short Label**, enter a name or descriptive text. If either one or both of the text fields are empty, the label area will display the number.  
**Note**: On some phones, the short label is a stub that doesn't show icon and/or text.
11. Click on **Apply** and **Save**.

## Example 2, Speed dialing

Besides using the **Speed Dial** page on the web interface to program speed dial numbers, you can also put the functionality on the SmartLabel keys with LEDs on the phone or a connected expansion module.

1. On the phone's web interface, click **Function Keys** in the left lateral menu.
2. Click **SmartLabel keys** (Line keys).
3. Select a page, if necessary.
4. Select a key.
5. Under **Type**, select "Speed Dial" from the drop-down list.
6. In the **Number** text field, enter the phone number that you want to be able to speed dial. In our example it is phone number 555-0123 in area code 917.  
Type each phone number with any necessary area code and/or country code etc. without spaces, hyphens, etc. Example: In conventional notation you might write the number as (917) 555-0123. Type 9175550123 into the text field.
7. Under **Context**, select "active" for all configured identities or one of the configured identities from the drop-down menu.
8. Select a display option from the drop-down menu of **Short Label Mode**. The default is "Icon and text", i.e., an icon depicting the function on the key and the number or the short label text will be displayed on the display. name or descriptive text.
9. Select a display option from the drop-down menu of **Full Label Mode**. The default is "Icon and text", i.e., an icon depicting the function on the key and the number or the short label text will be displayed on the display.
10. Optional: In the text fields of **Full Label** and **Short Label**, enter a name or descriptive text. If either one or both of the text fields are empty, the label area will display the number.  
**Note:** On some phones, the short label is a stub that doesn't show icon and/or text.
11. Click on **Apply** and **Save**.

You can now speed dial the number by pressing the LED key adjacent to the label.

### Example 3, Changing setting of context-sensitive key

You can select a different key event to be available on the four keys under the display when the phone is in idle mode. You cannot change the functions that are available when the phone is active, for example when you are in a call, when the phone is ringing, etc. In the following example, the setting of key F3 will be changed from **DND** to **Notifications**.

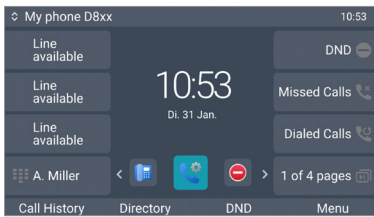

1. On the phone's web interface, click **Function Keys** in the left lateral menu.
2. Click **Context-sensitive keys**.
3. Scroll to F3 in the main window.
4. In the **Number** text field, select **Notifications** from the drop-down menu..
5. Click **Apply**.

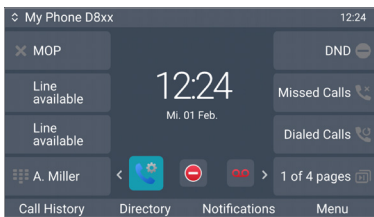

## Customizing the phone settings

See "The phone's web interface" on page 30 on how to open the phone's web interface, how the web interface works, and how to change the settings. See "User mode/administrator mode" on page 26 on the difference between administrator and user mode.

If you have access to administrator mode, but do not consider yourself to be an expert on SIP and SIP phones, we recommend that you do not change any of the technical settings since this may adversely affect the phone's performance or put it out of order altogether.

If you want more information on a web interface setting, click on the radio button with the question mark  that you see to the right of each item. It links to a page on Snom's Wiki with detailed information about that particular item.

On customizing the function key settings, see the chapter "Configuring the function keys" on page 52.

**Note:** Any changes you make on the web interface will not take effect until you click on **Apply**. Changes will be lost if you open another page or tab of the web interface or if you close the web interface without first clicking on **Apply**.

## Identities/accounts

The phone supports up to 8 accounts or "phone numbers" with one or more providers or within an office or organization network. On Snom phones these accounts or phone numbers are called "identities".

**Note:** If your phone is part of an office network, you may need to contact your administrator to configure new or change existing identities, as this can only be done when the phone is running in administrator mode and when the PBX settings allow it.

See "Initializing and registering the phone" on page 14 for more information on required input data.

## Configuring and editing identity/account

The settings are accessible in administrator mode only. In user mode it is possible to select a different outgoing identity and to reregister active identities.

Open the phone manager, click **Identities** in the menu on the left, and select a configured identity or **Add identity** to open the configuration menu.

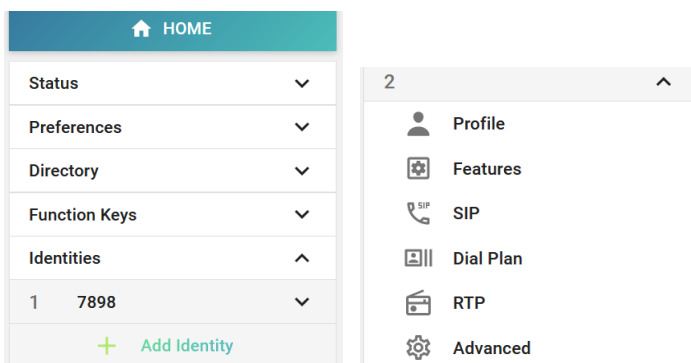

Click **Apply** to save your settings.



1. **Profile.** Enter the information received from your provider or your administrator in the appropriate fields.

- Display name

The display name is optional and freely selectable. It will be sent to any parties you call unless you hide your identity (see "Hiding my caller ID" on page 68). If you do not enter a display name, the data in the "Account" text field will be shown on your display and sent to any parties you call unless you hide your identity. Provider settings may override any text you enter.

- Account, password, registrar, outbound proxy, mailbox: please obtain this information from your service provider or your network's administrator.
- Display text and number for idle screen

Any text/number you enter in in these text fields will be shown - instead of your display name or account - on your display only. They will not be sent to any parties you call.

2. **Features.**

- **Call forwarding.** This feature automatically forwards all or certain incoming calls to another phone or a mailbox.

#### **Always**

All incoming calls are forwarded to the number of the phone, extension, or mailbox specified as this function's **target**. Alternatively, the function can be turned on and off with a star code if your PBX or provider offers this feature.

#### **When busy**

Calls ringing while the phone is busy are forwarded to the number of the phone, extension, or mailbox specified as this function's **target**. Alternatively, the function can be turned on and off with a star code if your PBX or provider offers this feature.

#### **After timeout**

When a call starts ringing, the phone will wait for the number of seconds specified as **wait time**. If the call has not been accepted by the end of this time period, it is forwarded to the number of the phone, extension, or mailbox specified as this function's **target**. Alternatively, the function can be turned on and off with a star code if your PBX or provider offers this feature.

- a. Click the on/off toggle to **on** for each forwarding event you want to set.

- b. Enter the target phone number/account. Alternatively, enter the star codes for **On Code** and **Off Code**.

- c. Click **Apply**.

- **DND - do not disturb mode** . When this function is turned on, callers hear the busy signal. If there is an active setting for call forwarding on busy, incoming calls will be forwarded to the number specified in the setting. If DND is handled by the PBX, the star codes are entered here.
- **Privacy settings.** When set to Hide, this setting suppresses sending your own number (CLIP/CLIR) during calls. May be overridden by provider or network settings.

3. **SIP settings.** Contain a number of technical settings and text fields for entering URIs/URLs to various servers (for music-on-hold, for example), as well as some behavior settings. These are:

- Automatic acceptance of incoming calls: **Auto Answer**. The default setting is **off**.

If you change the setting to on, you may also want to be alerted by a short beep when the phone accepts the call.

1. Click **Preferences**, then **Audio**.
2. Scroll down to **Auto answer indication** and click the on/off toggle to **On**.

**3. Click Apply.**

- Contact List. A contact list must be available on a server. Click **on** and enter the Contact List URI .
- Identity can receive calls. The default setting is **on**. If you want to be able to use the identity for outgoing calls but do not want other phones to be able to call the identity, turn the setting off.
- Allow incoming extension monitoring. If you do not want other phones to be able to monitor the activity on your phone, turn the setting **off**.

You can also allow only certain phones to monitor and pick up your calls. In this case, select the **On** setting and enter a password into the next field of the next setting, "Extension monitoring group ID". **The password cannot start with a "{" bracket.**

Any phone allowed to monitor and pick up your calls must also use the same password in this text field.

**Note:** If you want the activity on the monitored phones to be displayed on your idle screen, click **Preferences**, then **Phone behavior** in the Phone Manager's left lateral menu and enable the setting **Go to Call Monitor on Activity** by clicking **on**.

#### 4. Advanced.

- **Ringtones.**

The phone has 10 built-in ringtones that can be assigned to identities, group types, and contact types. It is also possible to download a custom melody and to turn off the ringer by selecting **Silent**. See "Assigning ringtones" on page 62.

You can also set a delay period in seconds before incoming calls begin to ring on the phone. During this delay period, incoming calls are announced visually only by the fast-blinking call LED and by the "ringing" message on the display.

- NAT identity settings. STUN and Keepalive - see explanations in phone manager.

## Assigning ringtones

The phone has 10 built-in ringtones that can be assigned to identities, group types, and the contact type **VIP**. It is also possible to download a custom melody. When an incoming call to an identity is ringing, the phone will play the ringtone assigned to that identity, unless it is a call from a VIP or from a group with a distinctive ringer of their own.

**Note:** Ringers assigned to the contact type VIP and to any of the group types override the ringers assigned to identities. For example, if you have assigned Ringer 1 to one of the identities and Ringer 2 to the group "Colleagues", the phone will play Ringer 2 when a contact from the "Colleagues" group calls that identity.

If your ringtones don't seem to work as expected, contact your administrator. There may be an overriding setting on the PBX.

**Assigning ringtones to contact type VIP and group types:** See "Ringtones" on page 33.

### Selecting identity ringtones on the phone

1. Press **Menu**, then **Preferences** and **Sound**.
2. Select **Ringer tone**. The tone setting applies to an identity. If there is more than one configured identity on the phone, they are shown on the display. If necessary, select the identity with  $\wedge$  /  $\vee$ .
3. Press  $\leftarrow$  /  $\rightarrow$  to scroll through the identities. Each ringtone is played.
4. Press **Back** to save the selected ringtone and return to the **Sound** display.

## Date and time formats

Date and time formats can be set on the web interface. The defaults are U.S. date format (mm/dd) and 24-hour clock.

### Date

Date	U.S. Date Format	
	Setting "On"	Setting "Off"
March 5, 2018	03/05/2022	05.03.2022
March 12, 2018	03/12/2022	12.03.2022
December 5, 2018	12/05/2022	05.12.2022
December 10, 2018	12/10/2022	10.12.2022

1. Click **Preferences** in the left lateral menu.
2. Click **Appearance**.
3. Scroll to **U.S. Date Format (mm/dd)** and click **off.m** if you want to change to European format (dd/mm/yr).
4. Click **Apply**.

### Time

The time setting affects phones and/or firmware versions with a digital clock only. The default setting is 24-hour clock.

1. Click **Preferences** in the left lateral menu.
2. Click **Appearance**.
3. Scroll to **24-Hour Clock** and click **off** if you want to change to 12-hour am/pm settings (00:01 am to 12:00 pm).
4. Click **Apply**.

### Time zone

The phone receives the time and date from your NTP time server. If the time and/or date on the display are incorrect, you may need to set the correct time zone. If you have set the correct time zone and the time is still incorrect, there may be a problem with the time server. Contact your network administrator or your IP provider.

The list of time zones is arranged by the difference in hours (+/-) to the UTC and, within each time zone, alphabetically by selected locations (country or country and city). Selecting and setting the time zone:



1. Click **Preferences** in the left lateral menu.
2. Click **Time & Date**.
3. Scroll to **Time**.
4. Select your location from the pull-down menu of **Time Zone**.
5. Click **Apply**.

## Language settings of phone and web interface

The language used on the phone can be changed on the phone as well as on the web interface. The language used on the web interface can be changed on the web interface only.

### Phone language

#### Setting on the phone

1. Press **Menu**.
2. Select **Preferences**.
3. Select **Language**. The currently set language is indicated by the radio button .
4. Select and save a different language with  $\wedge$  /  $\vee$  and pressing **Select** or . The display will return to the previous screen.

#### Setting on the web interface

1. Click **Preferences** in the left lateral menu.
2. Click **Language**.
3. Select the language from the pull-down menu of **Phone interface language**.
4. Click **Apply**.

### Web interface language

1. Click **Preferences** in the left lateral menu.
2. Click **Language**.
3. Select the language from the pull-down menu of **Web interface language**.
4. Click **Apply**.

## Dial tones

Different dial tones for different countries! Select yours on the web interface.

1. Click **Preferences** in the left lateral menu.
2. Click **Language**.
3. Select the language from the pull-down menu of **Phone interface language**.
4. Click **Apply**.

## Emergency numbers

These are numbers that can be dialed when the keyboard is locked. They must be set beforehand on the web interface. The numbers "911", "112", "110", and "999" are preset.

1. Click **Preferences** in the left lateral menu.
2. Click **Emergency Numbers**.
3. Add emergency numbers as applicable for your area and phone.
4. Click **Apply**.

## Keyboard locking

In the default setting, the keyboard can be locked for outgoing calls except for calls to the numbers defined as emergency numbers (see "Emergency numbers" on page 65) by TBA. Setting a PIN for locking and unlocking the keyboard is optional. On the web interface, the ability to lock the keyboard can be turned off. You can also define a time period of inactivity after which the keyboard will be locked automatically.

## Setting a PIN for locking and unlocking

Valid values are the digits 0–9. When you enter the digits—both on the phone and on the web interface—they are replaced by asterisks.

1. Click **Preferences** in the left lateral menu.
2. Click **Privacy**.
3. Scroll to **PIN to unlock** and enter the PIN in the text field.

**Note:** The text field always contains 8 dots, whether a PIN has been set or not and regardless of the length of the PIN.

4. Click **Apply**.

## Allow/disallow keyboard locking

In the default setting, the function is enabled. Setting on the web interface:

1. Click **Preferences** in the left lateral menu.
2. Click **Privacy**.
3. Scroll to **Allow keyboard locking**. The default setting is **on**.
4. Click **off** on the toggle switch if you want to turn keyboard locking off.
5. Click **Apply**.

## Automatic keyboard locking after inactivity

In the default setting, the function is disabled (blank text field). Valid values are positive integers. Setting on the web interface:

1. Click **Preferences** in the left lateral menu.
2. Click **Privacy**.
3. Scroll to **Lock keyboard after (s)**. The default setting is 0 (zero) seconds.
4. Enter the period of inactivity in seconds.
5. Click **Apply**.

## Call forwarding

This feature automatically redirects all or certain incoming calls to another phone or a mailbox. **Call forwarding is configured for each identity separately.**

### Always

All incoming calls are forwarded to the number of the phone, extension, or mailbox specified as this function's **target**.

### When busy

Calls ringing while the phone is busy are forwarded to the number of the phone, extension, or mailbox specified as this function's **target**.

### After timeout

When a call starts ringing, the phone will wait for the number of seconds specified as **wait time**. If the call has not been accepted by the end of this time period, it is forwarded to the number of the phone, extension, or mailbox specified as this function's **target**.

**Configuring the settings on the phone:** See "Call forwarding" on page 50.

## Configuring the settings on the web interface

If your internet telephony provider or your PBX uses codes to turn functions on and off, refer to their manuals for the codes to enter in **On Code** and **Off Code** text fields or ask your administrator.

### Setting the forwarding targets

1. Click **Identities** in the left lateral menu.
2. Click the identity.
3. Click **Features**.
4. Enter the **target** phone number/account for each call forwarding feature (always, busy, timeout) you want to set.
5. For timeout, also enter the number of seconds you want the phone to wait before forwarding the call to the target.
6. Enter the on and off star codes, if applicable.
7. Click **Apply**.

### Turning call forwarding on and off

1. Click **Identities** in the left lateral menu.
2. Click the identity.
3. Click **Features**.
4. Scroll to the call forwarding feature (always, busy, timeout) you want to turn on or off.
5. Click **on** or **off** on the toggle switch.
6. Click **Apply**.

## Call completion

On Snom phones call completion means that when a called number is busy or not available, your phone will call you back as soon as the dialed number is not busy anymore or available again. The factory default setting is **off**. For more information, see "Call completion" on page 41.

**Note:** This function must be supported by your VoIP provider and/or your PBX.

1. Click **Preferences** in the left lateral menu of the Phone Manager.
2. Click **Phone behavior**.
3. Click **on** or **off** on the toggle switch of **Call completion**.
4. Click **Apply**.

## Call waiting

Default setting: When in a call, another call coming in is announced visually in the status line and acoustically by a double beep. See "Call waiting" on page 44 on how to use this feature. Available settings:

- **On:** Visual and acoustic announcement of calls waiting
- **Visual only:** Visual announcement of calls waiting in the status line
- **Ringer:** Acoustic announcement by double beeps
- **Off:** The call waiting is not announced visually or acoustically; callers hear the busy signal.

Call waiting is set independently for each identity.

1. Click **Identity** in the lateral menu on the left of the Phone Manager.
2. Select the identity.
3. Click **SIP** in the submenu of the identity.
4. Scroll down to **Call Waiting Indication**.
5. Select a setting from the drop-down menu.
6. Click on **Apply**.

## Hiding my caller ID

With this setting your phone number will not be transmitted to any phones you call. Please note that your call may not be accepted if the other phone is set to reject anonymous calls (see "Rejecting anonymous calls" on page 68). The default setting is off (toggle switch setting **Show**), i.e., your identity is transmitted. Your PBX or IP provider may not allow hiding your caller ID.

1. Open the phone manager and select **Identities**.
2. Select the identity whose caller ID you don't want to transmit.
3. Click **Features**.
4. Scroll down to the **Privacy Settings** section.
5. Click the slider of the setting **Suppress own number (CLIP/CLIR)** to change the setting.
6. Click **Apply**.

## Rejecting anonymous calls

With this setting you will not receive calls from phones whose number is not shown on your display. Anonymous callers will hear the busy signal.

**Please note** that calls from analog phone connections will, most likely, be received as anonymous calls. The default is **off**.

1. Open the phone manager and click **Preferences**.
2. Click **Privacy**.
3. Click **on** or **off** on the toggle switch of **Reject incoming anonymous calls**.
4. Click **Apply**.

## Speed dial

You can use the numbers 0 to 9 to speed dial frequently dialed and/or long numbers without having to enter the complete phone number. The numbers must be set on the phone or on the phone's web interface first.

**Note:** You can also map a phone number onto each one of the SmartLabel keys and the context-sensitive keys F1–F4. For the programming instructions, see "Example 2, Speed dialing" on page 58 and "Context-sensitive keys" on page 55, respectively.

Type each phone number exactly how it needs to be dialed by the phone, i.e., with any required prefixes (area code, country code, operator/auto attendant, etc.) and without spaces or punctuation between the digits.



## Setting on the phone

1. Press **Menu** and select **Preferences > Programmable keys > Speed dial**. Phone numbers currently assigned to any speed dial numbers are indicated in the line underneath the respective speed dial number.

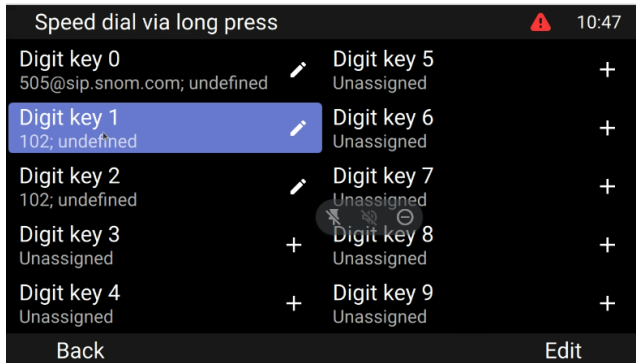

2. Use **^** / **v** to select a key.
3. Press **Edit**.
4. Type the phone number into the text field without spaces or punctuation between the digits
5. Press **Save** to save and to return to the speed dial menu.

## Setting on the web interface

1. Click **Function keys** in the left lateral menu.
2. Click **Speed Dial** in the Function keys menu.
3. Enter one phone number with any required prefixes (area code, country code, operator/auto attendant, etc.) in the text field for each respective number or special character in the table.

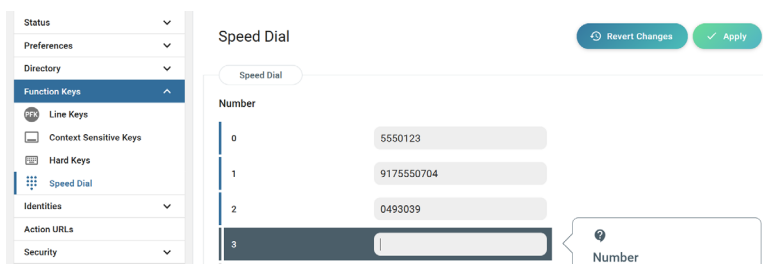

Type each phone number without spaces or punctuation between the digits.

**For example:** You want to be able to speed dial phone number 555-0784 in area code 917 by typing **1** on the keypad. In conventional notation you might write the number down as (917) 555-0784. In the speed dial table, type 9175550784 into the text field of the number 1.

4. Click **Apply**. You can now speed dial the number by long-pressing **1** and **Dial** or  on the phone.

## Auto dial

In the default setting, this function is switched off. When it is enabled, the phone will dial the number on the display when the time span in seconds specified in this setting has elapsed since the last digit was typed.

**Note:** Do not enter a target unless you want auto dial to be used only for one particular number. With the additional setting **Auto dial target**, this function can be used on phones restricted to dialing a single number, in waiting areas like airport lounges or waiting rooms, for example. For the settings restricting dialing to a predefined number, see "Auto dial target" on page 70.

1. Open the phone manager and click **Preferences**.
2. Click **Phone behavior**.
3. Scroll to **Auto dial timeout**.
4. Enter the number of seconds in the text field.
5. Click **Apply**.

## Auto dial target

In the default setting, this function is switched off. When a target has been set, the phone will dial the number when the time span in seconds specified in **Auto dial timeout** has elapsed after the receiver was taken off-hook.

1. Open the phone manager and click **Preferences**.
2. Click **Phone behavior**.
3. Scroll to **Auto dial target**.
4. Enter the phone number in the text field.
5. Click **Apply**.

# Software update

## Manual update

1. Go to <https://service.snom.com/display/wiki/Firmware+Update+Center>. and find the latest firmware version for your phone.
2. Please read the instructions and release notes before downloading the firmware.
3. Right-click the download link in the **Firmware files** table.
4. Open the phone manager and click **Maintenance**.
5. Click **Software update**.
6. Enter the phone number in the text field under **Firmware**.
7. Click **Load**.
8. **DO NOT DISCONNECT THE POWER WHILE THE PHONE IS REBOOTING!**

## Auto provisioning

For more information, see our web page <https://service.snom.com/display/wiki/Auto+Provisioning>.





1. Open the phone manager and click **Maintenance**.
2. Click **Provision**.
3. Click the individual settings for their details.
4. When done, click **Apply**.

## SRAPS

If you are using Snom's Secure Redirection and Provisioning Service (SRAPS), you can log in to your account via the link in the right lateral of the phone's **Home** page. For more information on SRAPS, see <https://service.snom.com/display/wiki/SRAPS>.

# Troubleshooting

## Reboot

1. Press **Menu**.
2. Select **System** with  $\wedge / \vee < / >$  and press **Select** or .
3. Select **Advanced** with  $\vee$  and press **Select** or .
4. Select **Reboot** and press **Select** or .
5. When asked whether to reboot, press **Yes** or .
6. Wait for the idle screen to reappear.

## Hard reboot





Disconnect the power, wait for 10 seconds, and reconnect. Wait for the idle screen to reappear.

**Warning:** Never disconnect the power during a firmware update!

## Reset to factory values

The phone can be reset to factory values in administrator mode only.

**Warning:** All customized settings will be lost!

1. Press **Menu**.
2. Select **System** with  $\wedge / \vee < / >$  and press **Select** or .
3. Select **Advanced** with  $\vee$  and press **Select** or .
4. Select **Factory reset** and press **Select** or .
5. When asked whether to reset, press **Yes** or .
6. Wait for the idle screen to reappear
7. See "Initializing and registering the phone" on page 14 on how to continue.

## TFTP Update

When there is no other way to get the phone to work (administrator password lost, etc.). See <https://service.snom.com/display/wiki/Updating+the+firmware%2C+recovery+via+Network> for more information.

**Warning:** All customized settings will be lost!

## Manual initialization

When automatic initialization via DHCP fails, enter the values for netmask, IP gateway, and DNS server manually after each prompt on the display.

## Contacting Snom Support

If you are not a Snom partner, please contact your seller or consult our troubleshooting knowledge base at <https://service.snom.com/display/wiki/Troubleshooting+How-to> first. You may find the answer to your question or problem in one of the topics there. **Submitting a ticket**

If you are a Snom partner, log in to the Snom Partner Portal at <https://sraps.snom.com/partner> and open a ticket.

## Submitting system and settings information

### System information

1. Open the phone's web interface > **System Information** page.
2. Copy the text under System Information into the email, if Support has asked you to contact them by email.

### Settings information

1. Open the phone's web interface > **Settings** page.
2. Copy the settings list into the email, if Support has asked you to contact them by email.

## Traces

Snom Support may ask you to submit a SIP Trace and/or a PCAP Trace to help them analyze your problem.

## Performing a SIP Trace

1. Open the Phone Manager and click **Maintenance**.
2. Click **Diagnostic**.
3. Click the **SIP Trace** tab.
4. Click **Clear** to clear the page.
5. Recreate the error to be documented in the trace.
6. Click **Copy**.
7. Submit to Support in whatever form they requested you to use.

## Performing a PCAP Trace

1. Open the Phone Manager and click **Maintenance**.

2. Click **Diagnostic**.
3. Click the **PCAP Trace** tab.
4. Click **Start** to start recording network traffic.
5. Click **Stop** to end recording
6. Click **Save** to save the file to your **Download** folder.
7. Submit the file to Support in whatever way they requested you to use.

## Appendix 1 - Display Symbols and Icons

### Symbols found in the function key line

The buttons symbolize the functions that are currently available for activation. Press the function key underneath the symbol to activate the function.

### Programmable function symbols

These are the word symbols displayed in the function key line when the phone is idle. They can be selected on the phone and on the phone's web interface. See "Configuring the function keys" on page 52 for more information. See "At a glance" on page 18 for the default settings; they may vary, depending on your network or IP provider.

Headset
ACD
Auto answer
Call forward
Intercom

Key event
Speed dial
Transfer
XML definition

### Key events

Call history
Conference
Contacts
Delete message
Directory
DND
Favorites
Help
Hide outgoing ID
Hold
Notification
Instant redial
LDAP directory
Missed calls
Monitor calls
Multicast zones

Next identity
Next page
OCI-P directory
Pool
Presence
Previous identity
Previous page
Reboot
Redial
Menu
Silent mode
Voicemail
Voicemail info
Dialed calls
Lock

## Context-sensitive symbols

These are the text symbols displayed in the function key line when the phone is active, for example when a call is ringing, when you are dialing, etc.

	Alert triangle - added to <b>Notification</b> text symbol when there new status messages (failed registration, missed calls, etc.)
123	Current input mode: numerals
2aB	Current input mode: numeral and lower and upper case letters
Abc	Current input mode: first letter upper case, following letters lower case
abc	Current input mode: lower case
ABC	Current input mode: upper case
Add	Add participant to conference
Add contact	Add contact to directory
Add group	Add group to directory
Answer	Answer incoming call
Back	Return to previous screen
Backspace	Delete character to the left of the cursor
Blind xfer	Blind transfer
Call again	Call number again after outgoing call was rejected
Call history	List of dialed, missed, and received calls
Cancel	Terminate call, action when in menus or editing
Clear	
Conference	Start a conference
Delete	
Details	Show details of call
Dial	Dial number/contact
Directory	Access the
Dismiss	Delete notification
Dismiss all	Delete all notifications
End call	
Forward	Transfer active or incoming call
Hold	Put call on hold
Ignore	
Locate	
Menu	Open phone's main menu
Mute	Mute the active call
New call	Call another number
Page down	
Page up	
Reject	Reject incoming call, caller hears busy signal
Rename	
Resume	Resume the selected call on hold
Save	















Search	
Select	
Select all	
Set filter	Set search or sorting filter
Transfer	Transfer the active call
Unselect all	







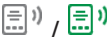



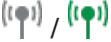













## SmartLabel function symbols



















These are the symbols displayed in the SmartLabel area of the programmable function keys P1–P32 when the function key page with the configured key is on-screen. For information on the configuration of the keys see "Configuring the function keys" on page 52.

## Programmable function symbols

These are the symbols of the functionalities selectable under "Type." Please note that not all available functionalities are represented by a symbol. If the selected type is "Key event", please see the table "Key event symbols," below.

Symbol	Text	Description
[Blank]	[Blank]	None
	Line available	
	Action URL	
	Auto answer	Auto answer on/off
	BLF	Busy lamp field
	Button	
	Call center status	
	Call forward	Forwarding all calls (turning on/turning off)
	Call lists	Call list menu (missed, received, and dialed calls)
	Missed calls	Missed call list
	Dialed calls	Redial (list of dialed calls)
	Conference	Start a conference
	Contacts	
	Contact (XMPP)	
	DND	Turn DND on and off
	DTMF	
	Extension number	Extension
	Intercom	Intercom (turning on/turning off)
	IVR	Interactive Voice Response
	Key event	See key events table, below

Symbol	Text	Description
	Mailbox	Access your messages
	Multicast paging	Multicast paging is off/on
	Park	
	Presence	
	Push-to-Talk	
	Record	
	Send SIP info	
	Smart transfer	
	Speed dial	One number per SmartLabel key to be dialed when key is pressed.
	Star code	
	Transfer	Transfer current call
	User input and Send SIP info	
	XML definition	
	Accepted calls	
	Alternate	
	Block caller	Deny all - reject current and all future calls from the number
	Call history	Call history menu (lists of missed, received, and dialed calls)
		Missed calls
		Conference
		Contacts / Presence state
	Consult conference	
	Contacts	
	Delete message	
	Dialed calls	
	Directory	Internal phonebook
	DND	Turning DND on/off) (red symbol = DND is on)
	Favorites	
		Delete message
		Push2Talk
		Forwarding all calls (turning on/turning off)
		Headset (select/turn off)
		Help

Symbol	Text	Description
	Hide outgoing ID	
		Hold
	Hoteling	Login (e.g., hotel)
	Notification	Alerts, status messages
	Instant redial	
		LDAP directory
	Logoff all	
	Menu	
	Missed calls	
		Monitor calls
		Multicast zones
	Mute	Mute microphone/unmute microphone (red symbol = microphone is mute)
	Next identity	Select outgoing identity
	Next page	Move forward to next SmartLabel page
	OCI-P directory	
	Pool	Available directories and call histories
	Presence	
	Previous identity	Select outgoing identity
	Previous page	Return to previous SmartLabel page
	Private hold	
		Reboot
	Record	Voice recorder is off/on (red symbol = call is being recorded) - check local regulations whether call recording is allowed. Phone does not have built-in voice recorder.
	Redial	
	Server directory	Phone settings
	Silent mode	
	Voicemail	Retrieve voice mail
	Voicemail info	

## Key event symbols

Accepted calls
Alternate
Block caller
Call history
Conference
Consult conference
Contacts
Delete message
Directory
DND
Executive assistant behalf of
Executive assistant config
Favorites
Help
Hide outgoing ID
Hold
Hoteling
Notification
Instant redial
LDAP directory
Logoff all
Missed calls
Monitor calls
Multicast zones

Mute
Next identity
Next page
OCI-P directory
Pool
Presence
Previous identity
Previous page
Private hold
Reboot
Record
Redial
Server directory
Menu
Silent mode
Voicemail
Voicemail info
Dialed calls
None
Lock

## Favicons



These are shortcuts to menus that can be accessed by selecting with < / > and pressing . From left to right: **Preferences** menu, **System** menu, **Call features** menu, **DND**, **Mailbox**.

The currently selected menu is highlighted. The default after bootup is **Call features**.

## Appendix 2 - Wall mounting

The bracket for wall mounting is available separately. Please, contact your seller or distributor for more information. Not included in the delivery are the two screws (diameter of head between 6 and 9 mm, diameter of body max. 4.5 mm) and two screw anchors/molly bolts/wall plugs appropriate for your type of wall.

The bracket is suitable for mounting the phone over American standard Ethernet wall plates and for mounting it on the wall without the wall plate.

- **On the wall without wall plate.**

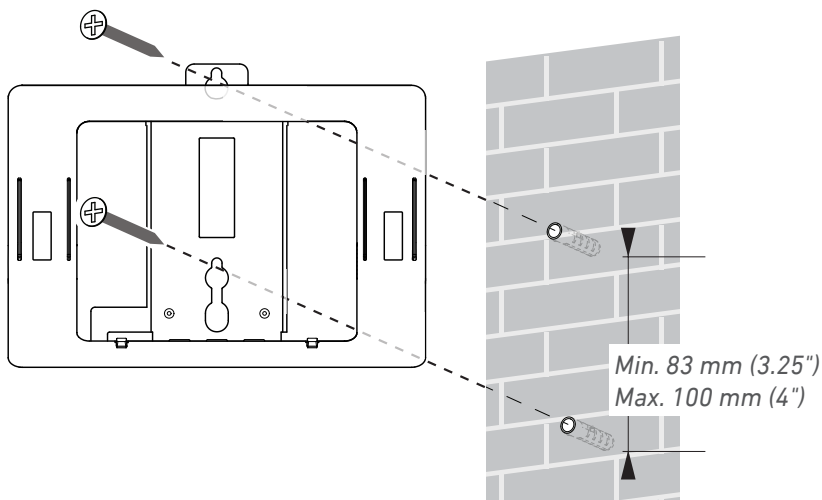

- **Over a standard Ethernet wall plate.**

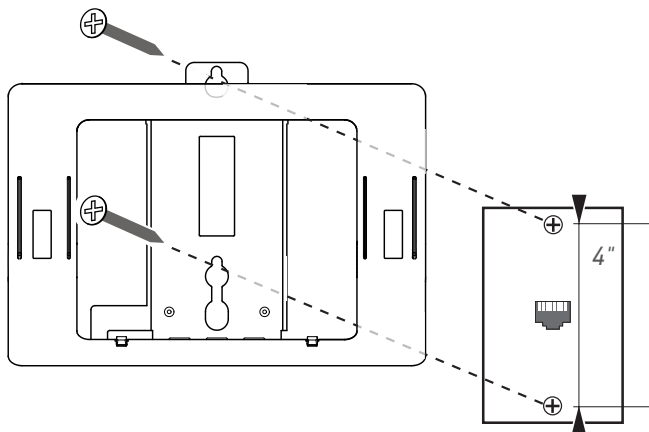

1. Place the anchors for the screws in the wall using the measurements given above.
2. Screw the bracket to the wall without or with the wall plate.
3. Plug the handset cord into the port labelled "☎" on the back of the phone and place the cord in the cable guide.
4. Plug the Ethernet cable into the port labelled "NET" on the back of the phone.

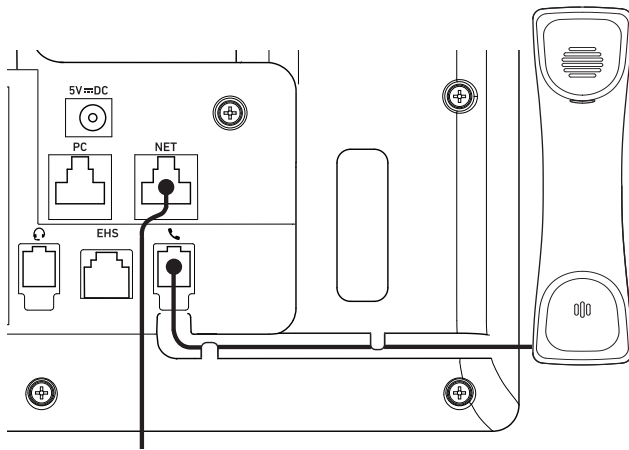

5. If you are using a wall plate, plug the Ethernet cable into the port on the plate.
6. Slide the phone onto the wall bracket until it clicks into place.

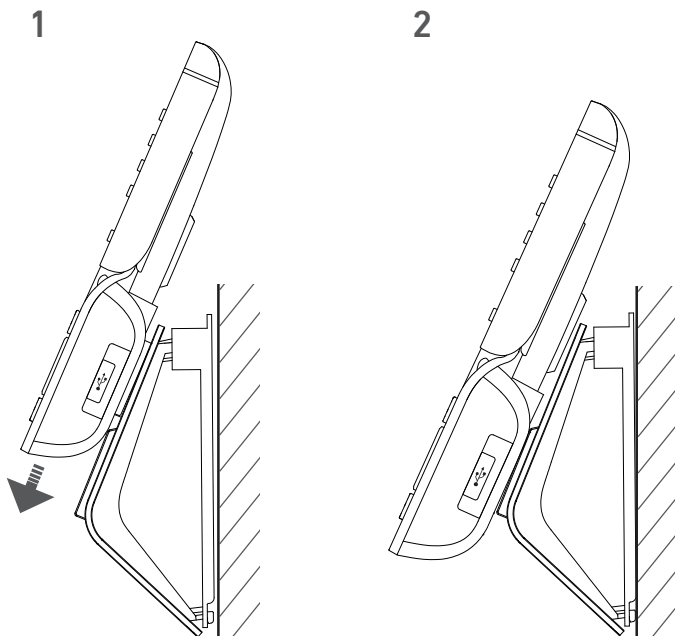

7. To hold the handset more securely on the tab of the cradle, rotate it 180° so that it protrudes slightly above the rim of the cradle. See "Rotating the tab of the cradle" on page 11. "

## Appendix 3 - Programmable Functions

Following is a brief description of the function key settings available on the **Function keys** page of the phone's web interface.



### Freely programmable functions

Action URL	Action URLs are basically HTTP GET Requests that allow the phone to interact with web server applications. They can be used to send various data from the phone to a web server, like the customized settings stored on the phone; passwords are replaced by empty strings. Action URLs can be triggered by predefined events ("Action URL Settings" page of the phone's web interface) or manually by a pressing a function key that has been programmed to trigger an action.
Auto Answer	With this setting, your phone will automatically accept incoming calls when it is idle. If you leave the text field empty, incoming calls for all configured identities will be accepted; if you enter the number of an identity in the text field, only calls to that identity will be accepted automatically (i.e., 1 for Identity 1, 2 for Identity 2 etc.).
BLF (Busy Lamp Field)	This function key allows showing the status (idle, ringing, held call, busy) of another extension on the key's LED. By pressing the key, it may also be possible to pick up calls ringing on the extension, to dial the extension when the phone is idle, and to transfer an incoming call ringing on your own extension. These functionalities depend on your PBX; for more information, please check snom's interoperability page and the PBX manual. With Asterisk, generally use this feature rather than extension.
Button	This is a function key that is connected to your PBX to perform a task specified in the buttons document. For more information, see the detailed feature description at <a href="http://wiki.snom.com/Features/LED_Remote_Control">http://wiki.snom.com/Features/LED_Remote_Control</a> .
Call Agent	This function key can be used by call agents to perform one of three different functions, depending on the value entered in the "Number" text field: <ul style="list-style-type: none"> <li>Logging onto and off the system. Text field entry: F_CALL_AGENT_LOGGEDIN.</li> <li>Signaling readiness to accept calls. For this function to work, the agent must be logged in. Text field entry: F_CALL_AGENT_READY.</li> <li>Announcing that they are working after a call. For this function to work, the agent must be logged in. Text field entry: F_CALL_AGENT_WORKINGAFTERCALL.</li> </ul>
Conference Server	This function key can be used for PBX-based conferences and for local conferences on the phone itself. <ul style="list-style-type: none"> <li>PBX-based conferences. When a conference room or conference account has been created on the server for an individual identity, you can dedicate a function key to calling and monitoring the conference room. Select the identity and the "Conference server" function from the respective drop-down menus and enter the SIP URI of the conference room in the "Number" text field. For information on how to use this key with your particular PBX, please check the PBX manual.</li> <li>Phone-based conferences. If there is no SIP URI in the text field, pressing the function key will initiate a phone-based conference with all held calls and any active call.</li> </ul>

DTMF	This function allows the specification of arbitrary key sequences (allowed digits: "0-9", "*", "#", "A-D" and flash: "!") which will be sent via DTMF when this key is pressed during an active call.
Extension	This function key allows showing the status (idle, ringing, held call, busy) of another extension on the key's LED. By pressing the key, it may also be possible to pick up calls ringing on the extension, to dial the extension when the phone is idle, and to transfer an incoming call ringing on your own extension. These functionalities depend on your PBX; for more information, please check snom's interoperability page and the PBX manual. With Asterisk, generally use BLF rather than this function.
Forward to	All incoming calls will be forwarded to the number (extension or external phone number) specified under "Number". The key is used to turn forwarding of all calls on and off; the red LED lights up when the function is turned on.
Intercom	<p>Pressing a function key mapped with "Intercom" will establish a two-way connection to the extension specified in the "Number" text field; that extension must have enabled intercom reception on its web interface (<b>Advanced Settings &gt; Behavior tab &gt; Phone Behavior &gt; Intercom Policy</b> "only in idle" or "always").</p> <p><u>"Intercom Policy" settings on the phone being called via intercom:</u></p> <p><b>Always:</b> The intercom call will connect to the called phone automatically; if the called phone is in a call, that call will be placed on hold.</p> <p><b>Only in idle:</b> The intercom call will connect to the called phone automatically if the called phone is idle. If it is in a call, the incoming intercom call will be announced as call waiting.</p> <p><b>Off:</b> Pressing the intercom key will call the extension specified in the "Number" text field where it will be treated like any other incoming call, i.e., ring, be forwarded, etc.</p>
IVR	<p>This function key can be used for regular calls to an extension that is reached via an IVR or auto attendant and a number of voice prompts where the caller has to make a selection by pressing a key after or during the prompt. If you know which keys need to be pressed in which order in order to reach the desired extension, the entire process can be automated and considerably speeded up.</p> <p>The syntax for the "Number" text field entry is <code>&lt;phone_number&gt;;dtmf=&lt;n&gt;,&lt;n&gt;</code>, etc. The angle brackets <code>&lt;&gt;</code> including their content are placeholders for the variables that you must replace by the actual characters. The comma represents a pause of one second, and <code>n</code> represents any number key on the alphanumeric keypad.</p> <p><b>Example:</b> The number to dial is (917) 555-3814. When the connection has been established, the caller will hear three prompts. After the first prompt, he must press key 1; after the second prompt, he must press 3; and after the third prompt he must press 1 to reach the desired extension. The entry in the "Number" text field must look like this: <code>9175553814;dtmf=1,3,1</code>.</p> <p><b>Usage:</b> When the phone is in idle mode, press the key to dial the number. As soon as the connection has been established, the phone will automatically send the DTMF tones associated with the alphanumeric keys 1, 3, and 1 with a one-second pause between them.</p> <p>(If the function type "IVR" doesn't work on individual phones, try "Speed dial" with the above description.)</p>
Key Event	When this key type is selected, a drop-down menu opens under "Number". For the available selections, see the following section "Key Events".





Line	<p>Default setting for all freely programmable function keys. Incoming calls will go to the first free "line" key, and outgoing calls will use the first free line key.</p> <p>Line keys can be used to make outgoing calls with the identity selected from a particular key's "Context" menu and to have incoming calls for that identity going to that particular function key. If the key is busy, the incoming call will go to the first free line key.</p>
Multicast Page	<p>This function key enables the phone to send multicast streams to IP multicast group addresses. The multicast IP address and port are entered in the "Number" text field in the format <i>&lt;multicast IP address&gt;:&lt;port&gt;</i> (e.g., 239.255.255.245:5555). The angle brackets <i>&lt;&gt;</i> including their content are placeholders for the variables that you must replace by the actual characters.</p> <p><b>Please note:</b> This key is for <b>sending</b> multicast streams. To <b>allow reception</b> of multicast streams, multicast support must be enabled on the phone's web interface, Advanced settings &gt; SIP/RTP tab &gt; Multicast by setting Multicast Support to "on". You must also enter the IP addresses of the multicasts you wish to receive in ascending order of priority, 10 being the highest. In case of simultaneous multicasts, the one with the highest priority at any given time will override the others.</p>
Park Orbit	<p>If a park orbit has been set up on the server, a function key mapped with the Park Orbit functionality can EITHER serve to park calls on the park orbit OR to park as well as retrieve calls, depending on the type of server used. Select the server type on the Configuration Identity page of the context identity, SIP tab, from the "Server Type Support" drop-down menu. Enter the "phone number" of the Park Orbit and/or the park position in the text field of "Number", for example orbit1@my.proxy.com or 700@my.proxy.com etc.</p>
Presence	<p>If supported by your PBX, the LED of this function key will reflect the presence status (ringing, busy, available, etc.) of the extension specified in the "Number" text field. The function key can also be used to dial the extension, usually when the destination signals availability.</p>
Push2Talk	<p>Pressing the function key mapped with "Push2Talk" will establish a two-way connection to the extension specified in the "Number" text field for as long as the key is pressed; that extension must have enabled intercom reception on its web interface (<b>Advanced Settings &gt; Behavior tab &gt; Phone Behavior &gt; Intercom Policy</b> "only in idle" or "always").</p> <ul style="list-style-type: none"> <li>• On 870 phones, this key type will establish an Intercom connection.</li> <li>• On 820/821 phones, this key type is only available on keys P2 and P3.</li> <li>• On 760 phones, this key type is not available on key P4.</li> </ul>
Shared Line	<p>Bridged lines (Bridged Line Appearance (BLA)) are shared by two or more users; when one of them is using the line, the others are blocked from using it. This key type makes it possible to monitor whether a shared line is busy (the LED is lit) or not (the LED is off). The URI of the shared line is set under "Number".</p>
Speed Dial	<p>Besides using the "Speed Dial" page on the web interface to program speed dial numbers, you can also put the functionality on the freely programmable function keys with LEDs to be able to speed dial frequently used and/or long numbers without having to enter the complete phone number.</p> <p>Enter one phone number with any required prefixes (area code, country code, operator/ auto attendant, etc.) in the "Number" text field for any given freely programmable function key with LEDs. Example: 0019175557813.</p> <p>Or enter a partial phone number (country, area code etc.) and complete the number on the dialog screen. In this case, enter the partial number, followed by a semicolon and "number=incomplete" in the text field. Example: 001917555; number=incomplete.</p>

Starcode	<p>Making SIP calls without audiovisual indication on the phone user interface (PUI).</p> <p>Examples for using this feature:</p> <ul style="list-style-type: none"> <li>Controlling settings on the PBX with dedicated keys that turn PBX functions on and off. The available functions must have been set on the PBX and they must be accessible from the phone, typically by dialing a star code. Phone function keys can be dedicated to activating and deactivating call forwarding and DND mode, transferring, picking up, and parking/unparking calls, etc. Depending on the settings on your PBX, you may either have to dedicate one key each for activating and deactivating a given function or to dedicate one key for both activating and deactivating the function.</li> <li>Silent alarms or emergency calls.</li> </ul> <p>If the standard behavior of this function key type does not meet your requirements, it is possible to customize it. Copy the standard XML configuration of the key from the Settings page of the phone's web user interface (WUI) and edit it to suit your needs. Then paste the edited XML into the "Number" text field and change the key's type to "Xml definition".</p>
Transfer to	<p>Transferring active calls and ringing incoming calls to the number set in the "Number" text field. Pressing the key once will transfer the active or ringing call.</p> <p>If the text field is empty, pressing the key will put the "Enter number" screen on the display. Enter the number and press  /  to complete the transfer.</p> <p>For further information, see the article "Transferring calls" in the chapter "Using the phone".</p>
Voice Recorder	<p>The phone does not record the voice streams at all; they must be recorded on the PBX where a recording account must be set up. Pressing the key when the phone is idle will establish a connection between the phone and the recording account, making it possible to record spoken memos, meetings, or conferences. Pressing the key during a call will establish a three-party conference with the two phones and the recording account as participants. Please be advised that you must respect the legal restrictions of your country for recording calls with or without the participants' knowledge and permission.</p>
Xml Definition	<p>Copy the XML sub tag of the action(s) you want the key to perform into the text field. The currently available settings can be found here: <a href="http://wiki.snom.com/Features/Mass_Deployment/Setting_Files/XML/XmlSubTags">http://wiki.snom.com/Features/Mass_Deployment/Setting_Files/XML/XmlSubTags</a>.</p>

## Key Events

ABS	Address book search (OCS accounts)
Accepted Calls	(Accepted List) List of calls accepted on the phone
Call Lists	Call history list (missed, received, dialed calls)
Change active ID	List of registered SIP identities
Conference	Starting a conference
Contacts	Contact List, where the Presence State of selected users can be seen (online, busy, offline)

Directory	Internal phone directory
DND	Turning "Do not disturb" function (DND) on or off. When mapped to a function key with an LED, the LED will light up when DND is turned on.
Favorites	Favorites list
Forward all	All incoming calls will be forwarded to another extension or an external phone number. After turning call forwarding on with this key, the display will prompt you to enter - or confirm/change a previously entered - forwarding number.
Help	FW versions lower than 8: Phone's IP address, MAC address, and firmware version.  FW 8 and higher: Phone's IP address and the URI to Snom Wiki. IP address, MAC address, and firmware version can be found in Settings > 6 Information > 2 System Information.
Hold	Placing the active call on hold
LDAP Directory	Allows the user to look up a remote directory while dialing. Once set, this pressed key will open up the Directory Search window. If LDAP is setup, corresponding matching entries as returned by the server will be shown. If LDAP is not used and presence_lookup_number setting is turned on, the contact matches will be shown. The default edit mode is alphanumeric in this state.
Logoff Identities	Caution: This option will delete all account settings!!  Usage: Mainly useful for call centers with frequently changing users.
Menu	Calling up the settings menu of the phone
Missed Calls	Missed call history list
Monitor Calls  (not available on Snom 300)	When the phone has been programmed to monitor extensions and do/allow call pickup, a key can be mapped to show the list of monitored extensions and do call pickup from the monitor.  FW v8.7.2 and higher: The list will show only active extensions (i.e., busy or ringing). When there is no activity on any monitored extensions, the list is empty.
Mute	Mutes/unmutes the microphone (handset, speakerphone, headset) during active call
Next Outgoing ID	Selecting the next identity as the outgoing identity
Presence State	Providing access to a list where the Presence state of each registered SIP Identity can be defined (online, offline, busy, invisible).
Prev. Outgoing ID	Selecting the previous identity as the outgoing identity
Reboot	Rebooting the phone
Record	The phone does not record the voice streams at all; they must be recorded on the PBX or other external device. Pressed during a call, the key informs the PBX to start and stop the recording of the audio stream on the PBX. While the call is being recorded, the recording symbol ● will either blink on the display or be displayed, in red ●, in the status line, depending on the phone type; if the function key has an LED, the LED will be lit throughout the recording. Please be advised that you must respect the legal restrictions of your country for recording calls with or without the participants' knowledge and permission.
Redial	Dialed call history list (last call at the top)
Retrieve	Retrieves new mailbox messages. This key becomes active when the phone has received a message waiting indication (MWI) with a valid mailbox URI.

Status Messages	Currently available status messages (see Appendix 2)
Transfer	<p>Transferring the active call or an incoming call that you do not want to pick up. See the article <b>Transferring calls</b> in the chapter <b>Using the phone</b>.</p> <p>Pressing the key will put the "Enter number" screen on the display. Enter the number and press  /  to complete the transfer.</p>

## Appendix 4 - GNU General Public License

### COPYRIGHT NOTICE AND WARRANTY DISCLAIMER

I.

Das Produkt enthält Software, die unter der GNU General Public License, Version 2, frei genutzt werden darf.

This Product contains Software applicable to GNU General Public License, Version 2 which can be used freely.

II.

Im Verhältnis zu den Lizenzgebern der Software gilt der folgende Haftungsausschluss:

Towards the licensor of this Software the following liability is disclaimed:

This program is distributed in the hope that it will be useful, but WITHOUT ANY WARRANTY; without even the implied warranty of MERCHANTABILITY or FITNESS FOR A PARTICULAR PURPOSE. See the GNU General Public License for more details.

III.

Der Lizenztext der GPL lautet wie folgt:  
The GNU General Public License is as follows:

#### GNU GENERAL PUBLIC LICENSE Version 2, June 1991

Copyright (C) 1989, 1991  
Free Software Foundation, Inc.  
59 Temple Place, Suite 330  
Boston, MA 02111-1307, USA

Everyone is permitted to copy and distribute verbatim copies of this license document, but changing it is not allowed.

#### Preamble

The licenses for most software are designed to take away your freedom to share and change it. By contrast, the GNU General Public License is intended to guarantee your freedom to share and change free software--to make sure the software is free for all its users. This General Public License applies to most of the Free Software Foundation's software and to any other program whose authors commit to using it. (Some other Free Software Foundation software is covered by the GNU Library General Public License instead.) You can apply it to your programs, too.

When we speak of free software, we are referring to freedom, not price. Our General Public Licenses are designed to make sure that you have the freedom to distribute copies of free software (and charge for this service if you wish), that you receive source code or can get it if you want it, that you can change the software or use pieces of it in new free programs; and that you know you can do these things.

To protect your rights, we need to make restrictions that forbid anyone to deny you these rights or to ask you to surrender the rights. These restrictions translate to certain responsibilities for you if you distribute copies of the software, or if you modify it. For example, if you distribute copies of such a program, whether gratis or for a fee, you must give the

recipients all the rights that you have. You must make sure that they, too, receive or can get the source code. And you must show them these terms so they know their rights.

We protect your rights with two steps: (1) copyright the software, and (2) offer you this license which gives you legal permission to copy, distribute and/or modify the software.

Also, for each author's protection and ours, we want to make certain that everyone understands that there is no warranty for this free software. If the software is modified by someone else and passed on, we want its recipients to know that what they have is not the original, so that any problems introduced by others will not reflect on the original authors' reputations.

Finally, any free program is threatened constantly by software patents. We wish to avoid the danger that redistributors of a free program will individually obtain patent licenses, in effect making the program proprietary. To prevent this, we have made it clear that any patent must be licensed for everyone's free use or not licensed at all.

The precise terms and conditions for copying, distribution and modification follow.

#### GNU GENERAL PUBLIC LICENSE

##### TERMS AND CONDITIONS FOR COPYING, DISTRIBUTION AND MODIFICATION

0. This License applies to any program or other work which contains a notice placed by the copyright holder saying it may be distributed under the terms of this General Public License. The "Program", below, refers to any such program or work, and a "work based on the Program" means either the Program or any derivative work under copyright law: that is to say, a work containing the Program or a portion of it, either verbatim or with modifications and/or translated into another language. (Hereinafter, translation is included without limitation in the term "modification".) Each licensee is addressed as "you".

Activities other than copying, distribution and modification are not covered by this License; they are outside its scope. The act of running the Program is not restricted, and the output from the Program is covered only if its contents constitute a work based on the Program (independent of having been made by running the Program). Whether that is true depends on what the Program does.

1. You may copy and distribute verbatim copies of the Program's source code as you receive it, in any medium, provided that you conspicuously and appropriately publish on each copy an appropriate copyright notice and disclaimer of warranty; keep intact all the notices that refer to this License and to the absence of any warranty; and give any other recipients of the Program a copy of this License along with the Program.

You may charge a fee for the physical act of transferring a copy, and you may at your option offer warranty protection in exchange for a fee.

2. You may modify your copy or copies of the Program or any portion of it, thus forming a work based on the Program, and copy and distribute such modifications or work under the terms of Section 1 above, provided that you also meet all of these conditions:

a) You must cause the modified files to carry prominent notices stating that you changed the files and the date of any change.

b) You must cause any work that you distribute or publish, that in whole or in part contains or is derived from the Program or any part thereof, to be licensed as a whole at no charge to all third parties under the terms of this License.

c) If the modified program normally reads commands interactively when run, you must cause it, when started running for such interactive use in the most ordinary way, to print or display an announcement including an appropriate copyright notice and a notice that there is no warranty (or else, saying that you provide a warranty) and that users may redistribute the program under these conditions, and telling the user how to view a copy of this License. (Exception: if the Program itself is interactive but does not normally print such an announcement, your work based on the Program is not required to print an announcement.)

These requirements apply to the modified work as a whole. If identifiable sections of that work are not derived from the Program, and can be reasonably considered independent and separate works in themselves, then this License, and its terms, do not apply to those sections when you distribute them as separate works. But when you distribute the same sections as part of a whole which is a work based on the Program, the distribution of the whole must be on the terms of this License, whose permissions for other licensees extend to the entire whole, and thus to each and every part regardless of who wrote it.

Thus, it is not the intent of this section to claim rights or contest your rights to work written entirely by you; rather, the intent is to exercise the right to control the distribution of derivative or collective works based on the Program. In addition, mere aggregation of another work not based on the Program with the Program (or with a work based on the Program) on a volume of a storage or distribution medium does not bring the other work under the scope of this License.

3. You may copy and distribute the Program (or a work based on it, under Section 2) in object code or executable form under the terms of Sections 1 and 2 above provided that you also do one of the following:

- a) Accompany it with the complete corresponding machine-readable source code, which must be distributed under the terms of Sections 1 and 2 above on a medium customarily used for software interchange; or,
- b) Accompany it with a written offer, valid for at least three years, to give any third party, for a charge no more than your cost of physically performing source distribution, a complete machine-readable copy of the corresponding source code, to be distributed under the terms of Sections 1 and 2 above on a medium customarily used for software interchange; or,
- c) Accompany it with the information you received as to the offer to distribute corresponding source code. (This alternative is allowed only for noncommercial distribution and only if you received the program in object code or executable form with such an offer, in accord with Subsection b above.)

The source code for a work means the preferred form of the work for making modifications to it. For an executable work, complete source code means all the source code for all modules it contains, plus any associated interface definition files, plus the scripts used to control compilation and installation of the executable. However, as a special exception, the source code distributed need not include anything that is normally distributed (in either source or binary form) with the major components (compiler, kernel, and so on) of the operating system on which the executable runs, unless that component itself accompanies the executable.

If distribution of executable or object code is made by offering access to copy from a designated place, then offering equivalent access to copy the source code from the same place counts as distribution of the source code, even though third parties are not compelled to copy the source along with the object code.

4. You may not copy, modify, sublicense, or distribute the Program except as expressly provided under this License. Any attempt otherwise to copy, modify, sublicense or distribute the Program is void, and will automatically terminate your rights under this License. However, parties who have received copies, or rights, from you under this License will not have their licenses terminated so long as such parties remain in full compliance.

5. You are not required to accept this License, since you have not signed it. However, nothing else grants you permission to modify or distribute the Program or its derivative works. These actions are prohibited by law if you do not accept this License. Therefore, by modifying or distributing the Program (or any work based on the Program), you indicate your acceptance of this License to do so, and all its terms and conditions for copying, distributing or modifying the Program or works based on it.

6. Each time you redistribute the Program (or any work based on the Program), the recipient automatically receives a license from the original licensor to copy, distribute or modify the Program subject to these terms and conditions. You may not impose any further restrictions on the recipients' exercise of the rights granted herein. You are not responsible for enforcing compliance by third parties to this License.

7. If, as a consequence of a court judgment or allegation of patent infringement or for any other reason (not limited to patent issues), conditions are imposed on you (whether by court order, agreement or otherwise) that contradict the conditions of this License, they do not excuse you from the conditions of this License. If you cannot distribute so as to satisfy simultaneously your obligations under this License and any other pertinent obligations, then as a consequence you may not distribute the Program at all. For example, if a patent license would not permit royalty-free redistribution of the Program by all those who receive copies directly or indirectly through you, then the only way you could satisfy both it and this License would be to refrain entirely from distribution of the Program.

If any portion of this section is held invalid or unenforceable under any particular circumstance, the balance of the section is intended to apply and the section as a whole is intended to apply in other circumstances.

It is not the purpose of this section to induce you to infringe any patents or other property right claims or to contest validity of any such claims; this section has the sole purpose of protecting the integrity of the free software distribution system, which is implemented by public license practices. Many people have made generous contributions to the wide range of software distributed through that system in reliance on consistent application of that system; it is up to the author/donor to decide if he or she is willing to distribute software through any other system and a licensee cannot impose that choice. This section is intended to make thoroughly clear what is believed to be a consequence of the rest of this License.

8. If the distribution and/or use of the Program is restricted in certain countries either by patents or by copyrighted interfaces, the original copyright holder who places the Program under this License may add an explicit geographical distribution limitation excluding those countries, so that distribution is permitted only in or among countries not thus excluded. In such case, this License incorporates the limitation as if written in the body of this License.

9. The Free Software Foundation may publish revised and/or new versions of the General Public License from time to time. Such new versions will be similar in spirit to the present version, but may differ in detail to address new problems or concerns. Each version is given a distinguishing version number. If the Program specifies a version number of this License which applies to it and „any later version“, you have the option of following the terms and conditions either of that version or of any later version published by the Free Software Foundation. If the Program does not specify a version number of this License, you may choose any version ever published by the Free Software Foundation.

10. If you wish to incorporate parts of the Program into other free programs whose distribution conditions are different, write to the author to ask for permission. For software which is copyrighted by the Free Software Foundation, write to the Free Software Foundation; we sometimes make exceptions for this. Our decision will be guided by the two goals of preserving the free status of all derivatives of our free software and of promoting the sharing and reuse of software generally.

#### NO WARRANTY

11. BECAUSE THE PROGRAM IS LICENSED FREE OF CHARGE, THERE IS NO WARRANTY FOR THE PROGRAM, TO THE EXTENT PERMITTED BY APPLICABLE LAW. EXCEPT WHEN OTHERWISE STATED IN WRITING THE COPYRIGHT HOLDERS AND/OR OTHER PARTIES PROVIDE THE PROGRAM „AS IS“ WITHOUT WARRANTY OF ANY KIND, EITHER EXPRESSED OR IMPLIED, INCLUDING, BUT NOT LIMITED TO, THE IMPLIED WARRANTIES OF MERCHANTABILITY AND FITNESS FOR A PARTICULAR PURPOSE. THE ENTIRE RISK AS TO THE QUALITY AND PERFORMANCE OF THE PROGRAM IS WITH YOU. SHOULD THE PROGRAM PROVE DEFECTIVE, YOU ASSUME THE COST OF ALL NECESSARY SERVICING, REPAIR OR CORRECTION.

12. IN NO EVENT UNLESS REQUIRED BY APPLICABLE LAW OR AGREED TO IN WRITING WILL ANY COPYRIGHT HOLDER, OR ANY OTHER PARTY WHO MAY MODIFY AND/OR REDISTRIBUTE THE PROGRAM AS PERMITTED ABOVE, BE LIABLE TO YOU FOR DAMAGES, INCLUDING ANY GENERAL, SPECIAL, INCIDENTAL OR CONSEQUENTIAL DAMAGES ARISING OUT OF THE USE OR INABILITY TO USE THE PROGRAM (INCLUDING BUT NOT LIMITED TO LOSS OF DATA OR DATA BEING RENDERED INACCURATE OR LOSSES SUSTAINED BY YOU OR THIRD PARTIES OR A FAILURE OF THE PROGRAM TO OPERATE WITH ANY OTHER PROGRAMS), EVEN IF SUCH HOLDER OR OTHER PARTY HAS BEEN ADVISED OF THE POSSIBILITY OF SUCH DAMAGES.

END OF TERMS AND CONDITIONS

### How to Apply These Terms to Your New Programs

If you develop a new program, and you want it to be of the greatest possible use to the public, the best way to achieve this is to make it free software which everyone can redistribute and change under these terms.

To do so, attach the following notices to the program. It is safest to attach them to the start of each source file to most effectively convey the exclusion of warranty; and each file should have at least the "copyright" line and a pointer to where the full notice is found.

```
<one line to give the program's name and a brief idea of what it
does>Copyright (C) <year> <name of author>
```

This program is free software; you can redistribute it and/or modify it under the terms of the GNU General Public License as published by the Free Software Foundation; either version 2 of the License, or (at your option) any later version.

This program is distributed in the hope that it will be useful, but WITHOUT ANY WARRANTY; without even the implied warranty of MERCHANTABILITY or FITNESS FOR A PARTICULAR PURPOSE. See the GNU General Public License for more details.

You should have received a copy of the GNU General Public License along with this program; if not, write to the Free Software Foundation, Inc., 59 Temple Place, Suite 330, Boston, MA 02111-1307 USA

IV.

Den vollständigen korrespondierenden Sourcecode der Software schickt Ihnen die Snom Technology GmbH auf Nachfrage gerne auf einem üblichen Datenträger gegen Erstattung der Herstellungskosten in Höhe von EUR 10,- zu.

Der vollständige korrespondierende Sourcecode kann auch über unsere Website unter <https://www.snom.com/footer/snom-entdecken/agb/quellcode-gpl-open-source/> heruntergeladen werden.

If requested by you, the complete corresponding source code of the Software can be sent by Snom Technology GmbH on a standard data storage medium against the reimbursement of the manufacturing costs of EUR 10.- per unit.

The complete corresponding source code of the Software can also be downloaded from our web site <https://www.snom.com/en/footer/discover-snom/gtc/source-code-gpl-open-source/>.

V..

Weitere Informationen finden Sie auch unter <http://www.snom.com>.

For further information see <http://www.snom.com>.

Snom Technology GmbH  
Wittestr. 30 G  
13509 Berlin, Deutschland  
office.de@snom.com

Snom Technology GmbH  
Via Milano 1  
20020 Lainate, Italia  
office.it@snom.com

Snom Technology GmbH  
The Courtyard, High Street  
Ascot, Berkshire SL5 7HP, UK  
office.uk@snom.com

Snom Technology GmbH  
130 avenue Joseph Kessel  
78960 Voisins-le-Bretonneux, France  
office.fr@snom.com

VTech Communications Inc.  
Snom Americas  
9020 SW Washington Square Road,  
Suite 555  
Tigard, OR 97223  
U.S.A.

VTech Technologies Canada Ltd.  
Suite 222  
12888 Wireless Way  
Richmond, B.C. V6V 0A3  
Canada

**Manufacturer:**

VTech Telecommunications Ltd.  
23/F., Tai Ping Industrial Centre, Block 1,  
57 Ting Kok Road, Tai Po  
HONG KONG

Your specialist retailer - Ihr Fachhändler -  
Votre distributeur - Su distribuidor - Il tuo rivenditore:

⌞

⌞

⌞

⌞